

# Emerging Strategies for EtO Abatement and Monitoring in the Workplace: Sonata Scientific's Helios™ and Picarro's Workplace Monitoring System

PICARRO

SONATA  
SCIENTIFIC

**Figure 1.** Sonata Scientific Helios™ HP100 (left) and the Picarro Workplace Monitoring System (right) empower facilities to fundamentally better understand and control their facility EtO levels.

SONATA  
SCIENTIFIC

Sonata Scientific LLC is a Connecticut-based developer of advanced industrial air purification products. The company is focused on innovative products to control and manage fugitive EtO emissions and other environmental challenges. Sonata's Helios™ platform continuously destroys volatile organic chemicals (VOCs) at room temperature over a wide range of inlet concentrations, including 1 ppb–10 ppm, where existing catalytic and adsorbent technologies may fall short.

PICARRO

Picarro Inc. is a California-based world-leading manufacturer of gas instruments and instrumented system solutions. Its CEMS, Workplace, Fenceline, and Mobile systems for ethylene oxide monitoring lead the industry in accuracy, precision, stability and ease of use. Its Workplace Monitoring System allows facilities to monitor 25 points in roughly a 10-minute cycle, providing companies with data essential to keeping workers safe.

## Summary

Over roughly the last decade, the medical device sterilization industry has faced increasing scrutiny around the use of the sterilant gas ethylene oxide (EtO) after a series of sentinel events and resulting personal injury suits. These events, and accompanying new regulations, have put intense pressure on sterilization facilities to adopt the most advanced monitoring and control strategies available to limit their liability and achieve regulatory compliance. However, companies looking to meet the requirements of the new rules must limit community and worker exposure through facility enhancements without significantly interrupting the flow of critical goods through the medical device supply chain. Achieving effective abatement in problem areas like office spaces and laboratories on discrete HVAC circuits, and warehouse areas with freestanding finished goods, has been particularly challenging.

This white paper discusses the performance of a new, low-power, photocatalyst-based technology for abating EtO in these settings—Sonata Scientific's Helios EtO control technology platform—with performance validated using the demonstrated capabilities of Picarro's EtO Workplace Monitoring System (WMS).

The remarkable performances of the Picarro and Sonata Scientific systems are part of a wider, next-generation technology revolution in the measurement and abatement of EtO and other hazardous chemicals in the workplace.

We examine extensive real-world EtO datasets from participating sterilizer facilities equipped with Picarro's WMS, and then simulate these real-world conditions in laboratory settings to assess the effectiveness of Sonata Scientific's Helios solution. We focus particularly on reducing EtO to levels below 10 ppb, the target level proposed in the original promulgation of the FIFRA rule for EtO workplace exposure. We demonstrate that the Helios achieves destruction and removal efficiency (DREs) of 98% and above (typically 99%+), even when the air matrix is complicated by water vapor, carbon dioxide, methane, and common cleaning agents.

The remarkable performances of the Picarro and Sonata Scientific systems are part of a wider, next-generation technology revolution in the measurement and abatement of EtO and other hazardous chemicals in the workplace. Products described in this white paper promise to fundamentally empower facilities to understand and control their facility EtO levels toward the greater goal of improving human health—a goal entirely consistent with the critical value EtO sterilization brings to the medical supply chain.

## Introduction

Effective abatement of EtO in commercial sterilizer facilities has challenged industrial engineers and hygienists for decades. EtO sterilization was first developed by the US military in the 1940s, and was subsequently refined in the 1950s when the McDonald process was developed for sterilizing medical devices in dedicated sterilization chambers.<sup>1</sup>

Process strategies like McDonald's focused on containment and passivation of EtO during

sterilization—where EtO was well above its lower explosive limit and far beyond safe exposure limits—using negative-pressure-regulated sterilizer chambers and inert balance gases like nitrogen, carbon dioxide, and chlorofluorocarbons. Sterilizer chambers allowed not only for containment but also for quick mechanical abatement of the EtO in the chamber through air flushes that originally sent the process gas to vents or stack flares and later to wet scrubbers, thermal oxidizers, and eventually, catalytic oxidizers.

These early sterilization processes were introduced in a world where the main concerns revolved around explosion and immediate toxicity. As the risk to human health at lower EtO levels became clearer, additional control mechanisms, like aeration chambers, back-vent interlocks, and dry bed fugitive emissions scrubbers were put in place to limit worker exposure and facility concentrations of EtO to single-digit part-per-million (ppm) levels. Aeration chambers were added to house recently sterilized finished goods for at least 8 hours, and up to several days, when the most significant EtO off-gassing occurs. Dry beds were also added to pull large volumes of gas through scrubbing media at room temperature, either scrubbing EtO from process gas going to the stack, or scrubbing EtO from ambient air so that it could be recirculated back into the facility to minimize the need to condition fresh outdoor air. Additional back-vents, or “chamber exhaust vents” were added with chamber door interlocks to reduce worker exposure during chamber unloading by pulling ambient air into the chamber and venting the chamber air either to atmosphere or to another scrubbing mechanism.

Although these methods have no doubt significantly improved the health and safety of workers and neighboring communities, new and revised regulations in the US and throughout the world are requiring facilities to further lower stack emissions and workplace EtO levels, including the newly-published 2024 EtO NESHAP revision (40 CFR Pt 63 Subpart O)<sup>II</sup> and FIFRA PID<sup>III</sup>.

The unique attributes of EtO significantly complicate comprehensive reduction of its fugitive emissions,

though. For example, EtO does not exit a facility predictably like CO<sub>2</sub>, which engineers often use to gauge air turnover and dispersion in a facility. EtO permeates building materials and continues to off-gas from product long after sterilization and even aeration are complete. This can be seen in data from warehouse quarantine areas (Figure 2, Area (2)) outside a permanent total enclosure (PTE), where product that was sterilized days prior can cause ambient EtO to soar to double-digit ppms if fugitive emissions abatement isn't in place. In some laboratory (3) and office spaces (1), HVAC systems recirculate a large portion of moved air to minimize the need to cool or heat incoming air, trapping fugitive EtO that would have been abated within a PTE. Furthermore, building materials do not always isolate EtO within PTEs because they may be as permeable to the gas as the medical equipment that EtO is used to sterilize!

Further complicating the ability to achieve low part-per-billion (ppb) levels of EtO in facilities is the fact that many legacy analyzer technologies show significant false positive spiking from common chemicals like isopropanol (IPA) and water vapor. Because of these interferences, facility supervisors often understandably doubt the veracity of readings from these legacy devices.

In this white paper, we present data that brings new clarity to these dynamics using real-world datasets taken at participating sterilizer facilities with the Picarro WMS, a system resilient to common interferences, and capable of measuring EtO at the ultra-low ppb levels required by FIFRA. With this information, we then evaluate the Sonata Scientific Helios platform in laboratory settings that mimic these real-world conditions to assess its capacity to abate EtO at ppb to ppm levels.

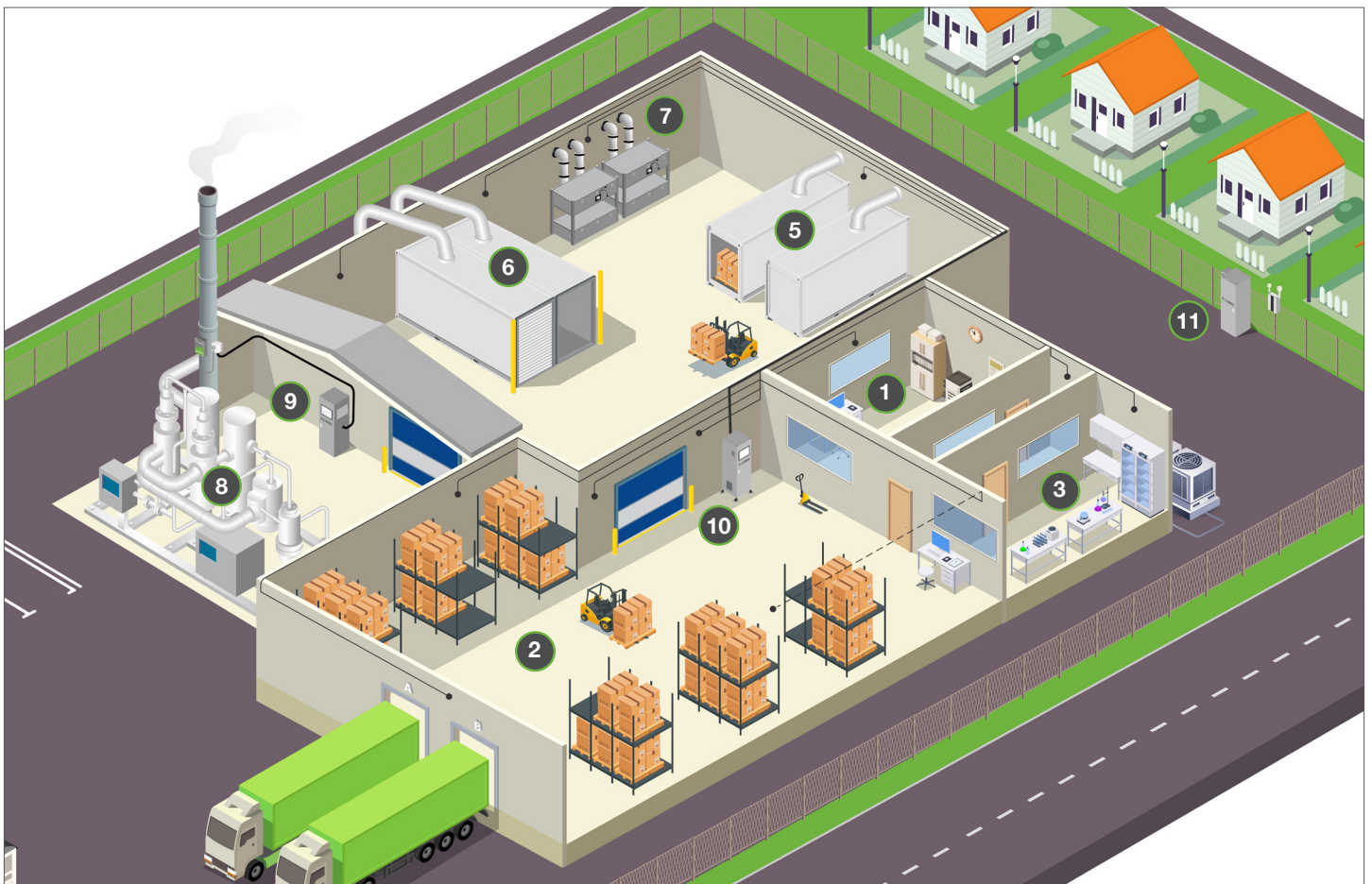

**Figure 2.** Schematic illustrating the typical areas of an EtO sterilization facility as used today. A PTE area is isolated at the top from the other areas by blue rollup doors, housing sterilization chambers (5), aeration cells (6) and dry beds (7) in between. A CatOx (8) is seen at the far left connecting to the stack which accommodates a Picarro CEMS (9). The Picarro WMS (10) sits in the middle of the image with black lines radiating out to sampling points, while the Picarro fenceline system (11) is also visible on the far right near the houses. The three workplace settings discussed in this paper are annotated as (1), Office areas with HVAC; (2), warehouses near bay doors; and (3), laboratory spaces, or otherwise complex matrices.

## Methods

### Helios Technology Platform

Sonata Scientific's Helios product line is designed to abate small-molecule VOCs, including low-boiling-point molecules such as EtO, formaldehyde, acetaldehyde, and isopropyl alcohol (IPA), all in low-power simple form factors.

The EtO control technology in Sonata Scientific's Helios product line combines a proprietary catalyst with an engineered photoreactor to drive high, sustainable EtO DRE at levels consistent with indoor fugitive EtO emissions across a wide range of environmental conditions. The Helios platform uses light instead of heat to continuously convert EtO to CO<sub>2</sub> and H<sub>2</sub>O, achieving critical illumination levels in mere moments, avoiding long start-up sequences. High performance is achieved by engineering the way light and EtO-laden air are delivered to the active material.



**Figure 3.** Sonata Scientific Helios technology platforms. (Left) Laboratory-scale Helios 2.0 for small-scale demonstrations and (right) Helios MP100 for on-site facility evaluations.

The Helios technology platform starts at laboratory-scale reactors (0.5-20 SLM) designed to provide demonstrations of DRE performance under real-world test conditions (Figure 3, left) and includes higher flow systems (100 CFM and greater) for on-site sterilizer applications (Figure 3, right). As companies wrestle with the challenges of both abating EtO at the stack and in the workplace, Sonata's EtO control systems will play an essential role both as standalone solutions now and as components of integrated industrial abatement systems in the near future.

### Picarro WMS: A CRDS Solution

Picarro's cavity ring-down spectrometer (CRDS) systems provide stable, sensitive, selective, and simple measurements of trace gas EtO for industrial monitoring, including CEMS, Workplace, Fenceline, and Mobile systems.



**Figure 4.** Picarro Workplace Monitoring System (left) with inset images of CEMS, Fenceline, and Mobile systems (top to bottom).

The Picarro Workplace Monitoring System featured in this white paper can sample from up to 25 points in a facility, with a typical cycle taking measurements at each position over 24 seconds for full characterization of a facility in just 10 minutes. The WMS uses a simple touch-screen interface, consumes ~400W, has an integrated uninterruptible power supply (UPS) for continuity, and is mounted on heavy duty casters. It can be rolled into place, plugged into the simplest 120/250V 60/50Hz 15A service, hooked up to lines, and running in a facility in about an hour.

The WMS can accurately characterize EtO from single digit ppbs to over 100 ppm, and reports single averaged, auto-calibrated, values at each position, with flagging for data quality, flow errors, high, and high-

high alarms. The sensitivity and dynamic range of the core instrument within the WMS allows for extremely accurate assessment of DRE for abatement systems like the Helios. In commercial sterilizer settings, inlet concentrations can range from double-digit ppbs to double-digit ppms, while the outlet concentrations can be on the order of single-digit ppbs—or even lower.

To demonstrate the power of this technology, consider the real-world data shown in Figure 5 below from a participating commercial sterilizer partner.

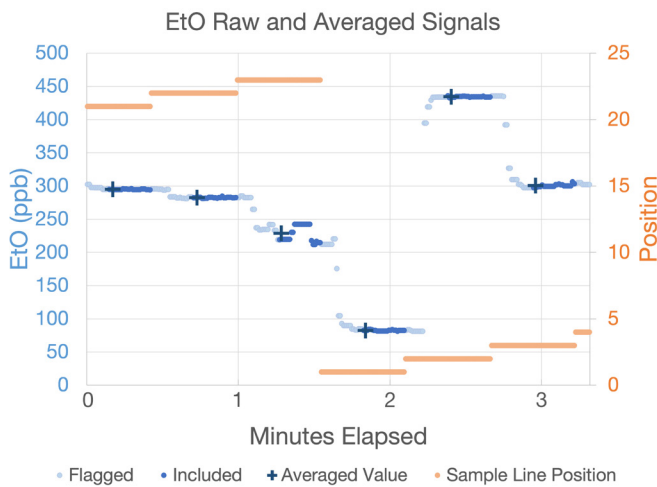

**Figure 5.** WMS real-time (dots) and averaged (crosses) data shown against sample position (orange dots).

In this example, we show data collected across multiple **positions** to demonstrate the resiliency of the averaging algorithm to bias. **Dead time transition data is marked with light blue dots. Data points used to calculate the average are shown with darker blue dots, and the computed averages themselves are shown as dark blue crosses time-stamped to the beginning of the averaging period.** Averages computed at positions 1 and 2 show clearly that the transitional data between samples ( $T_{90} < 5$  sec) is not averaged into the final value, leaving the calculated averages unbiased by the prior sample. Also visible in the raw data is the fact that some areas, like those sampled on positions 21 and 2 have clear homogenous sampling atmospheres, while occasional others like position 23 show evidence of dynamic processes at the sample point, like the movement of recently sterilized product.

Picarro workplace monitoring systems are deployed at sterilizer facilities across the world, and Picarro employees have spent many cumulative months with staff on site understanding and characterizing the complexity of EtO's movement around the facilities. The systems are frequently also used to help customers make important decisions about facility abatement system upgrades and capital expenditures.

The Workplace Monitoring System moves quickly and cleanly between positions. Its algorithm flags transitional data so that the computed average is unbiased by prior position values.

### Three Different Workplace Scenarios

In this white paper, we highlight three different workplace environments where EtO is present but challenging to abate with conventional approaches such as dry beds and CatOx/RTOs. Picarro has observed these three types of “problem areas” across a broad range of facilities, both small and large, traditional and modernized.

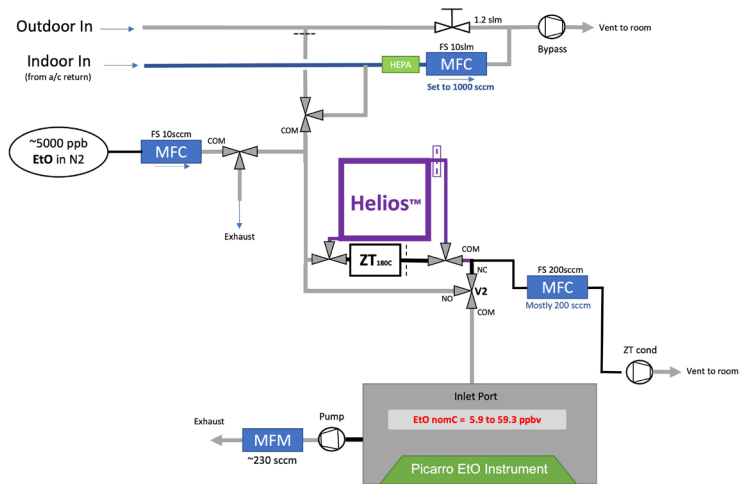
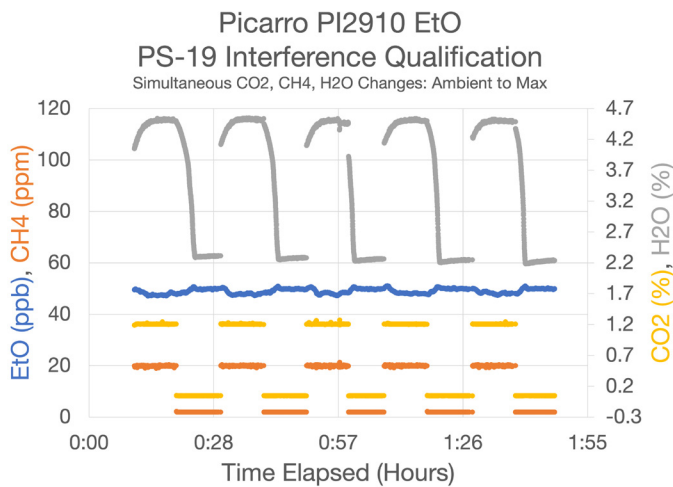

**Figure 6.** Testing setup for assessing the Helios performance in real-world ambient conditions (slightly simplified for clarity).

As mentioned previously, we first present real-world data showing the sorts of concentrations and air matrices found in sterilizer settings. We then simulate these scenarios with experimental conditions shown in

Figure 6. The figure consolidates the functional elements of multiple experiments discussed below.

In each case, EtO is introduced into the Picarro WMS and into the Helios (and often a third-party reference material) to determine true zero values, inlet EtO values, and outlet EtO values (i.e. the EtO concentration exiting the Helios). In some experiments, additional gases like acetone, IPA, and ambient CO<sub>2</sub>, CH<sub>4</sub>, and H<sub>2</sub>O are added to evaluate the performance and DRE of the Helios under real-world conditions.



**Figure 7.** PS-19 Results—Test data produced during EPA Performance Specification 19 analyzer qualification. Here, Picarro chose to introduce all interferent compounds to the gas stream simultaneously, the most challenging scenario to pass. Even with ultra-high CO<sub>2</sub> well beyond what is seen in ambient settings, and water vapor equivalent to an Amazonian forest after a rain shower, the most affected instrument showed only a ~1.4 ppb bias.

Importantly for this white paper and the experimental setups described below, the core Picarro CRDS instrument within the WMS is highly resistant to interferences, natively correcting for any possible bias from a host of compounds including CO<sub>2</sub>, CH<sub>4</sub>, H<sub>2</sub>O (see Figure 7), ethylene, ammonia, and methylene chloride, and is resilient to bias from other compounds found at commercial sterilizer sites, like acetaldehyde, an impurity in and isomer of EtO found at roughly a <0.5% level in the EtO supplied for sterilization. (Figure 8)

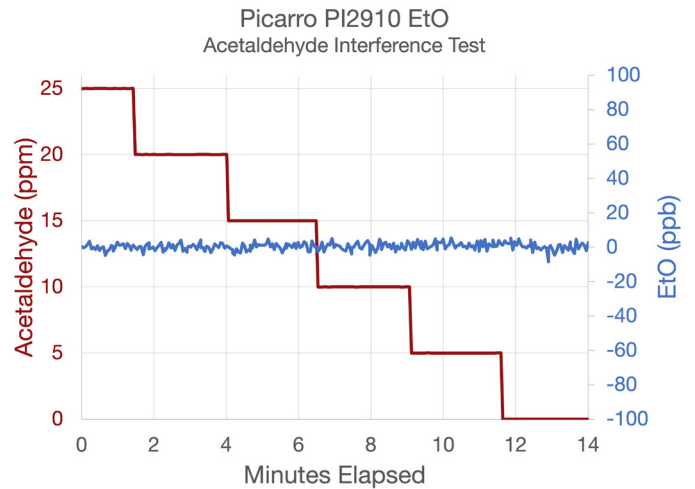

**Figure 8.** EtO concentrations when challenged with acetaldehyde (note the 250x larger Y axis range for acetaldehyde). Even with a heavily enriched acetaldehyde level of 25 ppm, the EtO showed no bias. Sterilizer GCs typically struggle with this challenge gas, since EtO and acetaldehyde are isomers, and typically co-elute.

As a final backstop against very abundant or unknown compounds, Picarro has equipped its EtO CRDS instruments with a data quality indicator that looks for deviations in the fit quality, flagging all affected EtO data. During the experiments described in this paper, we performed extensive quality checks with the gases mentioned to ensure that Picarro’s spectroscopic corrections were accurately characterizing EtO concentrations despite the presence of these other gases, so that we can be certain the destruction efficiencies presented are due exclusively to the Helios system’s abatement performance. In all cases, we found excellent performance by the Picarro, which remained completely unaffected by the significant changes in multiple matrix gases. This suggests not only that it is a highly suitable instrument for the types of testing presented in this paper, but also that it is an excellent system for handling these same matrix changes you might expect in sterilizer facilities.

## Workplace Setting One: Trapped and Permeating EtO at High Concentrations

The first setting investigated is not uncommon in sterilization facilities: high EtO levels trapped in office areas adjacent to a PTE or other process area (Figure 9). These areas are usually climate-controlled using a dedicated HVAC system separate from the plant’s main areas, providing reasonably low humidity



**Figure 9. Workplace Setting One:** At-risk spaces near process areas. These areas have higher fugitive EtO concentrations than others.

and simple air matrices. However, because of their proximity to high-use areas where product is sterilized or sits after sterilization, these areas often have persistently high EtO levels. EtO in these environments may be introduced by frequent traffic entraining EtO through doorways, especially when warmer air from process areas tends to rush into the cooler office spaces. EtO may also permeate into these areas via cracked or permeable wall materials, depending on how well the pressure differentials are maintained between building areas.

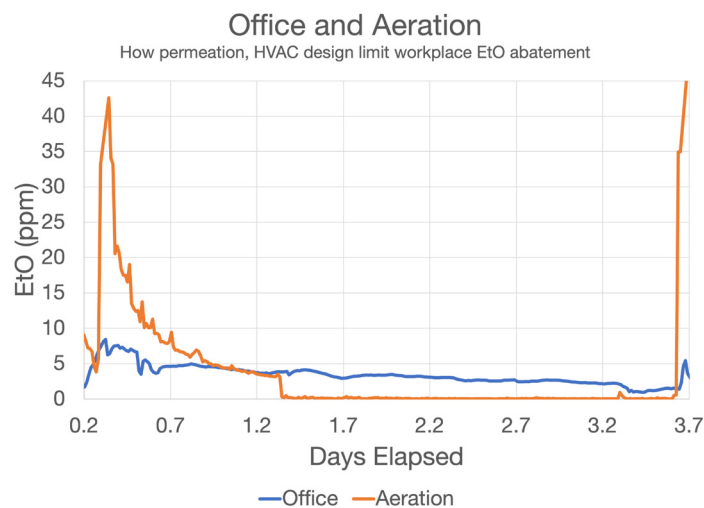

**Figure 10.** Office (blue) and Aeration (orange) Facility EtO time series data, showing high concentration (ppm levels) in office spaces adjacent to process areas. Proximity to sterilization areas has a clear effect on EtO concentrations in seemingly protected spaces.

Data from an **aeration room outlet vent** and an **office adjacent to the aeration chamber** are shown in Figure 10. As the unloading of the chambers and the loading of the aeration room begins (hour 0.2), the **concentration in the aeration chamber** rapidly increases to above 40 ppm, as expected from recently sterilized goods. However, EtO concentrations elsewhere in the facility also quickly increase because of the outgassing from these newly unloaded pallets, as evidenced by the uptick in the **blue office space tracer** at the same time. The concentration in the aeration chamber drops quickly, to roughly 3 ppm after mark 1.2 (roughly a day later), and then drops below a ppm as the product is removed from the chamber. In contrast, the concentration in the office area remains high even two days after the removal of the aerated product, and jumps back up when the next pallets are loaded into the aeration chamber a second time. While the magnitude of the effects shown above is not seen at all facilities, it is also not particularly rare.

In the example facility shown in the isometric graphic in Figure 9, the aeration cells and sterilization chambers on the left are set in a PTE to manage process and fugitive emissions. Even in facilities without PTEs, areas near aeration and sterilization are at least supplied by fresh air from large building fans (constantly) and loading docks (periodically), which help draw down ambient levels. The office space, in contrast, is on a dedicated HVAC circuit without any fugitives scrubbing. A significant portion of this air is recirculated because venting previously cooled air is inefficient. Recirculation traps the EtO within these air-conditioned spaces in this case, causing it to remain at single-digit ppm levels long after the primary source of EtO has left the adjacent aeration chamber.

The first set of Helios assessments were designed to match this type of setting, anticipating that abatement could be achieved either with room-specific Helios units sitting at the desktop or in-duct units integrated in the AC system.

In all cases, EtO DRE is above 99%, indicating excellent removal efficiency across a broad range of EtO concentrations.

These conditions were replicated by sending a simple EtO-in-air gas matrix to the Helios at concentrations gradually increasing from 56 to 5000 ppb (5 ppm), roughly the upper limit of what was observed in the Figure 10 office space data, using a laboratory setup similar to that shown previously in Figure 6. Table 1 lists the inlet EtO, outlet EtO, and calculated DRE for EtO levels tested. During testing, RH was set to 40%, typical of most indoor AC systems where relative humidity (RH) is kept low to discourage mold.

In all cases, the Helios was able to attain a DRE above 99%, indicating excellent removal efficiency across a broad range of EtO concentrations. The results highlight that up to the current OSHA 8-hr TWA Permissible Exposure Limit (PEL), a single-pass is adequate to abate EtO to below the 10 ppb FIFRA PID level contemplated by the EPA at various times over the last years.

Additional testing of DRE as a function of RH was run using an EtO inlet concentration of 1.2 ppm (Figure 11).

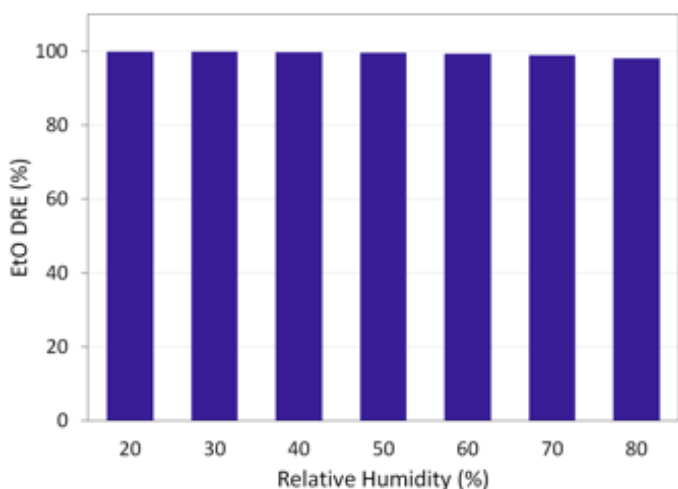

Figure 11. Helios 2.0 EtO DRE as a function of RH.

High abatement (99+% DRE) could be achieved at up to 60% RH with only a slight decrease observed (98+% DRE) at higher RH.

While the Helios demonstrates excellent single-pass EtO DRE, the authors recognize that EtO concentration dynamics in a target area are complex. A high DRE EtO control product will continually reduce ambient EtO levels throughout the space as the room air cycles through the reactor. Future experiments will characterize the in-room performance of Helios products in sterilization facilities and in the downstream medical device supply chain.

EtO Inlet (ppb)	EtO Outlet (ppb)	DRE (%)
56	ND*	99.6**
140	0.4	99.7
330	1.7	99.5
500	2.5	99.5
1000	6.4	99.4
5000	25	99.5

\*below detection limit of 0.25 ppb  
 \*\*assessed using detection limit of 0.25 ppb

Table 1. Helios 2.0 EtO DRE for typical workplace concentrations

## Workplace Setting Two: Warehouse Areas near Bay Doors

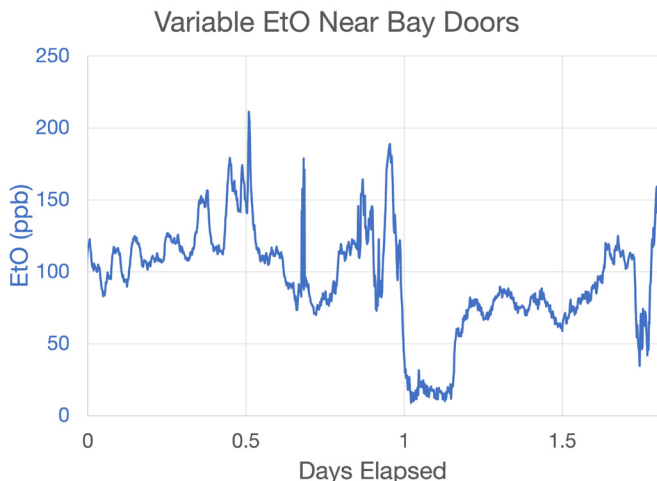

Figure 12. Workplace Setting Two: Warehouse/Quarantine Areas near bay doors where outdoor air is frequently entrained.



Warehouse environments contain low levels of other gases and VOCs, which are entrained into the facility by open bay doors or forced air fans (Figure 12). These settings typically have high flows of air piped in from outside, and when bay doors are opened, negative pressure gradients from these building circulation systems typically pull in fresh air and exhaust fumes from the bay doors. As a result, these areas have lower **ambient EtO levels** than process areas and potentially lower EtO levels than many climate-controlled areas (e.g. Figure 13, particularly seen at time mark 1, where values dip to nearly 0 ppb).

Even with inlet values at a low 30.5 ppb, the Helios was able to achieve 98%+ DRE in indoor and outdoor ambient air matrices.



**Figure 13.** Data from an area of the warehouse adjacent to the shipping bay doors showing frequent dips and rises associated with opening and closing of these bays and other facility doors.

Given that this air is less conditioned than the climate-controlled air of the first scenario, the efficiency of the Helios at removing EtO in these environments depends on the ability to function well in humid and highly complex gas backgrounds. We conducted a series of tests using standard addition methods to evaluate the EtO DRE of the Helios in actual ambient outdoor and indoor air matrices. During these tests, the laboratory testing setup shown in Figure 6 was configured to introduce outdoor or indoor air at predictable ratios

with EtO gas to provide a low concentration of 30.5 ppb EtO, a fairly typical concentration near bay doors in sterilizer facilities. The average results of these experiments after several iterations are shown in Table 2. The resulting DRE for outdoor settings was 98.4%, while the DRE for indoor air was 99.1%. At these low levels where the interpretation is limited by the method detection limit of the experiment (0.25 ppb in this case) these two efficiencies are nearly equivalent, although there is a small chance that the outdoor air is slightly harder to effectively scrub than the indoor air. The room-temperature removal of EtO at 98+% DRE highlights the effectiveness of the Helios control technology at removing EtO, even at these very low levels, in air matrices complicated by wide ranging RH and additional contaminants.

Interferent	EtO In (ppb)	EtO Out (ppb)	DRE (%)
Outdoor Air	30.5	0.5	98.4
Indoor Air	30.5	ND*	99.1**

\*below detection limit of 0.25 ppb

\*\*assessed using detection limit of 0.25 ppb

**Table 2.** Helios 2.0 EtO DRE of standard-added outdoor and indoor air

### Workplace Setting Three: Complex Air Matrices, Laboratory Settings



**Figure 14. Workplace Setting Three:** Areas where other common chemical are used, e.g., laboratory settings, kitchens, janitorial spaces.

It is common for EtO electrochemical sensors to respond when nearby work involving solvents or cleaning agents is performed. With uncertainty around false positives, facilities have a hard time assessing their risk in sterilizer laboratory settings (Figure 14). Many workplace settings involve the presence of other gases and VOCs, including cleaning agents such as IPA and acetone, and they frequently include perfumes and deodorants worn by workers.

Picarro’s work in factory settings has led to a series of demonstrations where Picarro systems are able to deliver reliable data in the face of complex matrices. In Figure 15, **seven fresh perfume tabs** containing various alcohols and fragrances were set up one inch away from the inlet of the Workplace Monitoring System while **an identical line** was stretched out 6 feet to the side. Data was taken over roughly an hour comparing the two values reported. The near perfect agreement of the two datasets over that time, along with other similar demonstrations of resilience to interferences, are powerful evidence of the performance of the Picarro WMS in complex matrices.

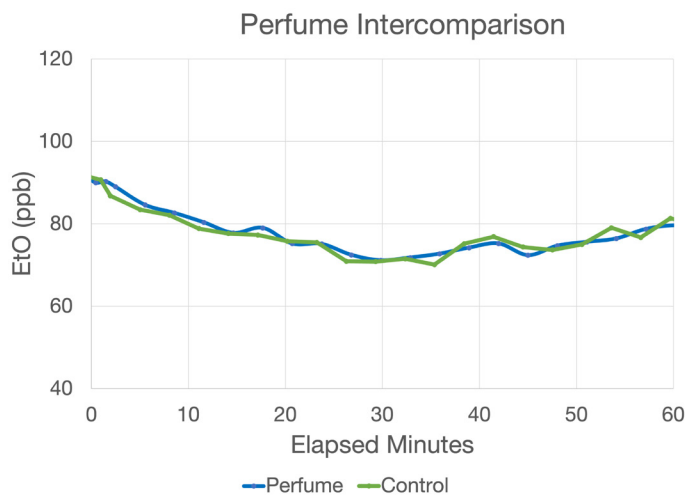

**Figure 15.** Picarro data at a commercial sterilizer showing that heavy, immediately adjacent perfume loads had no effect on the ambient Picarro readings (~80 ppb) compared to the control.

In the lab setting, carefully regulated levels of IPA or acetone, variously, were added to ambient air containing regulated amounts of EtO to evaluate the impact of these VOCs on EtO DRE. EtO inlet and outlet concentrations and DRE are shown in Table 3 at two inlet concentrations. The top half of Table 3 includes

data with EtO inlet values at 990 ppb (~1 ppm), while the lower half shows EtO inlet at 1460 ppb (~1.5 ppm) to see whether concentration of EtO affects DRE. In both cases, the Helios is initially allowed to abate only EtO coming from the tank before the interferent (IPA or acetone) is introduced. Next the interferent is added at values relevant in workplace settings near 8-hr PELs to demonstrate its impact on the EtO DRE. In all cases, the Helios achieves 99.9+% DRE in a pure EtO stream, with only minimal reductions in efficiency seen with the interferent gases (typically 99.8%). These results illustrate the exceptional capability of the Helios system to remove EtO, even in the presence of common VOCs.

Interferent	EtO In (ppb)	Interferent (ppm)	EtO Out (ppb)	EtO DRE (%)
Acetone	990	0	0.36	99.9+
Acetone	990	1	1.07	99.9
Acetone	990	3.1	2.18	99.8
IPA	990	0	0.34	99.9+
IPA	990	13	1.04	99.9
IPA	990	63	2.32	99.8
Acetone	1460	0	0.92	99.9
Acetone	1460	2.8	2.06	99.8
IPA	1460	0	0.93	99.9
IPA	1460	56	3.62	99.8

**Table 3.** Helios DRE with relevant ambient concentrations of acetone and IPA interferences.

## Conclusions

Throughout this white paper, we have shown data taken by Picarro Workplace Monitoring Systems in three distinct workplace settings in participating commercial sterilizers. Data from the workplace monitoring systems show the great resiliency of the core CRDS technology to interferences and carryover, and show its ability to represent concentrations across a wide dynamic range. These data provide critical situational information about the real-world conditions within EtO sterilizers from which experiments can be derived to test the real-world performance of Sonata Scientific’s Helios abatement systems.

Our experiments show that the Sonata Scientific Helios systems can handle the chosen inlet conditions—

ranging from 30.5 to 5000 ppb—handily with excellent DRE above 98.4% for low concentrations, and as high as 99.9% in most scenarios. These efficiencies are maintained despite challenging air matrix elements like isopropyl alcohol, acetone, CO<sub>2</sub>, CH<sub>4</sub>, and H<sub>2</sub>O, indicating that the Helios systems are well suited for use in office, laboratory, and warehouse settings.

Sonata Scientific is currently evaluating its 100 CFM EtO control system at several select medical device sterilization facilities. DRE above 99% has been achieved, consistent with the results we report in this white paper. Sonata is also in the process of developing a 500 CFM product for later in 2024, and continues to target higher CFM flow rates typical of commercial ducting and blower fans.

Please reach out to Sonata Scientific or Picarro Inc. for any sales or technical questions. We would be happy to assist you with your abatement and monitoring needs!

## Glossary

<b>CatOx:</b>	Catalytic Oxidizer
<b>CEMS:</b>	Continuous Emission Monitoring System
<b>CFM:</b>	Cubic Feet per Minute
<b>CFR:</b>	Code of Federal Regulations
<b>CRDS</b>	Cavity Ringdown Spectroscopy or Spectrometer
<b>DRE:</b>	Destruction and Removal Efficiency
<b>EPA:</b>	Environmental Protection Agency
<b>EtO, EO:</b>	Ethylene Oxide
<b>FIFRA:</b>	Federal Insecticide, Fungicide, and Rodenticide Act
<b>IPA:</b>	Isopropyl Alcohol
<b>MDL:</b>	Method Detection Limit
<b>NESHAP:</b>	National Emission Standard for Hazardous Air Pollutants
<b>PID:</b>	Proposed Interim Decision
<b>PPB/PPM</b>	Parts Per Billion/Million
<b>PTE:</b>	Permanent Total Enclosure
<b>RTO:</b>	Recuperative Thermal Oxidizer
<b>SLM:</b>	Standard Liters Per Minute
<b>VOC:</b>	Volatile Organic Compounds
<b>WMS:</b>	Workplace Monitoring System

# PICARRO

## Jonathan Bent, Ph.D.

Senior Program Manager,  
Environmental Solutions

[eto@picarro.com](mailto:eto@picarro.com)

[picarro.com/eto](http://picarro.com/eto)

## SONATA SCIENTIFIC

## Melissa Petruska, Ph.D.

Vice President of Product Development

[sales@sonatascientific.com](mailto:sales@sonatascientific.com)

[sonatascientific.com](http://sonatascientific.com)

The Authors would like to recognize contributions from Karsten Baumann, Dave Miller, and Sara Kato (Picarro) and Mostafa Dehghanizadeh, Robert Henderson, Thomas Spoonmore, and Peter Van Buskirk (Sonata Scientific).

This project is supported in part by the Food and Drug Administration (FDA) of the U.S. Department of Health and Human Services (HHS) as part of a financial assistance award R43FD007588, totaling \$791,000 with 100 percent funded by FDA. The contents of this publication are those of the author(s) and do not necessarily represent the official views of, nor an endorsement, by FDA/HHS, or the U.S. Government.

<sup>i</sup> McDonald Process, US Patent No. 3,068,064A

<sup>ii</sup> Revised NESHAP: <https://www.federalregister.gov/documents/2023/04/13/2023-06676/national-emission-standards-for-hazardous-air-pollutants-ethylene-oxide-emissions-standards-for>

<sup>iii</sup> FIFRA PID: <https://www.federalregister.gov/documents/2023/04/13/2023-07727/pesticide-registration-review-proposed-interim-decision-and-draft-risk-assessment-addendum-for>