

PICARRO

G2123 Analyzer for NH₃/H₂O User Manual



Picarro, Inc.

3105 Patrick Henry Drive
Santa Clara, CA 95054, USA

Phone: +1 408 962 3944

www.picarro.com

Document Number 40-0051 Rev. B

Picarro Analyzer User Manual

Thank you for purchasing a Picarro product. Your Picarro system is a quality product that has been designed and manufactured to provide reliable performance.

This User Manual (UM) is an important part of your purchase as it will help familiarize you with the system and explain the numerous features that have been designed into it. Please read this manual thoroughly before using your Picarro system.

Please contact Picarro or your authorized Picarro distributor should you have questions regarding specific applications or if you require additional information.

NOTICES

DISCLAIMER AND RESERVATION OF RIGHTS

Picarro has prepared this manual solely for the information and use by its customers as a guide for the selection, installation, operation, and maintenance of the products described.

EXCEPT AS PROVIDED IN THE TERMS AND CONDITIONS OF SALE FOR PICARRO PRODUCTS, PICARRO ASSUMES NO LIABILITY WHATSOEVER, AND PICARRO DISCLAIMS ANY EXPRESS OR IMPLIED WARRANTY, RELATING TO SALE OR USE OF PICARRO PRODUCTS, INCLUDING LIABILITY OR WARRANTIES RELATING TO MERCHANTABILITY OR FITNESS FOR A PARTICULAR PURPOSE.

Picarro reserves the right to change or update the contents of this manual and the specifications of its products at any time, without notice. Picarro has endeavored to include information that is current and accurate as of the date of the publication or revision of this document, but Picarro does not guarantee that this document is error free or that it is accurate with regard to any particular specification.

Picarro expressly reserves all intellectual property rights, including all intellectual property rights relating to any product described in this manual. This document does not grant any license, express or implied, by estoppel or otherwise, to any intellectual property rights of Picarro or any third party.

PATENTS

The products described in this manual are subject to Picarro patents and patents pending. Information about Picarro patents applicable to these products is available at www.picarro.com/company/patents

TRADEMARKS

Picarro and the Picarro logo are trademarks of Picarro, Inc.

Windows® is a trademark of Microsoft Corporation

Swagelok® is a trademark of Swagelok Company

Copyright © 2020 Picarro, Inc. All rights reserved

Contact Information

General Technical Support:

Email: support@picarro.com

Phone: +1 408 962 3991

European Technical Center:

Email: support@picarro.com

Phone: +31 85 888 1650

Customer Service:

Email: orders@picarro.com

Phone: +1 408 962 3992

Picarro, Inc. reserves the right to change or update the contents of this manual and to change the specifications of its products at any time without prior notification. Every effort has been made to keep the information in this document current and accurate as of the date of publication or revision. However, no guarantee is given or implied that this document is error-free or that it is accurate with regards to any specification.

Picarro, Inc. has prepared this manual for use by its customers as a guide for the proper installation, operation and/or maintenance of the Picarro analyzer.

Picarro and the Picarro logo are trademarks of Picarro, Inc.

© 2020 Picarro, Inc. All rights reserved.
3105 Patrick Henry Drive
Santa Clara, California, 95054 USA
Phone +1 408 962 3900 • Fax +1 408 962 3200
www.picarro.com

Table of Contents

1. INTRODUCTION TO TECHNOLOGY	6
1.1 CAVITY RING-DOWN SPECTROSCOPY (CRDS)	6
1.2 RELATING RING-DOWN TIME TO ABSORPTION INTENSITY	7
1.3 CONVERTING ABSORPTION INTENSITY TO CONCENTRATION.....	8
1.4 SPECTRAL PRECISION AND HIGH SENSITIVITY MEASUREMENTS.....	9
2. CONVENTIONS	11
3. ACRONYMS	12
4. SAFETY.....	13
4.1 GENERAL SAFETY.....	13
4.2 LASER SAFETY	14
5. UNPACKING THE ANALYZER.....	16
5.1 INSPECT THE SHIPPING BOXES.....	16
5.2 UNPACK THE SHIPPING BOXES	16
6. ANALYZER OVERVIEW	19
6.1 INTENDED USE	19
6.2 EXTERNAL VACUUM PUMP.....	19
6.3 ANALYZER SPECIFICATIONS.....	20
7. INSTALLATION.....	21
7.1 ANALYZER AND VACUUM SETUP.....	22
7.2 CONNECTING TO THE ANALYZER INLET.....	24
7.3 SETTING UP A MONITOR, KEYBOARD, AND MOUSE.....	25
8. ANALYZER BASIC OPERATION	26
8.1 STARTUP PROCEDURE	26
8.2 DESKTOP ICONS AND FOLDERS.....	27
8.3 SHUTDOWN PROCEDURE.....	29
8.4 IN CASE OF AN ELECTRICAL POWER OUTAGE.....	30
9. LIST OF GUI FUNCTIONS.....	31
9.1 GUI OVERVIEW	31
9.2 SETTINGS, TOOLS, AND HELP MENUS.....	31
9.3 ALARM PANEL.....	32
9.4 INSTRUMENT STATUS	33
9.5 DATA LOG FILENAME AND PATH.....	33
9.6 DATA WINDOW	34
9.7 STATUS LOG WINDOW	37
10. FILE MANAGEMENT	39
10.1 OVERVIEW	39
10.2 DATA FILE ARCHIVAL AND AUTOMATIC DELETION OF OLD FILES.....	40
10.3 SETUP TOOL.....	41
11. CALIBRATION.....	49
11.1 SLOPE AND OFFSET	49
11.2 CALIBRATION METHODOLOGY.....	49
11.3 CALIBRATION SOFTWARE UTILITY TOOLS.....	52
12. TROUBLESHOOTING.....	60
12.1 POWER LED ON ANALYZER DOES NOT ILLUMINATE	60
12.2 USER INTERFACE PROGRAM DOES NOT START.....	60
12.3 SAMPLE PRESSURE CANNOT BE CONTROLLED TO THE APPROPRIATE VALUE FOR CONCENTRATION MEASUREMENTS	61

12.4 USER INTERFACE PROGRAM "FREEZES" AND DOES NOT UPDATE GRAPHS AS DATA ARE COLLECTED	61
13. SERVICE AND MAINTENANCE	62
13.1 CONSUMABLES AND REPLACEMENT PARTS	62
13.2 PARTICULATE FILTER REPLACEMENT	62
13.3 CASE FAN ASSEMBLY REPLACEMENT	67
13.4 CPU FAN REPLACEMENT	69
13.5 REPLACING VACUUM DIAPHRAGMS AND VALVES	69
13.6 CLEANING	80
14. TRANSPORTATION AND STORAGE	81
15. LIMITED WARRANTY	82
APPENDIX A – REMOTE DATA ACCESS.....	83
APPENDIX B – THE DATA FILE VIEWER	87
APPENDIX C – EXTERNAL VALVE SEQUENCER	100

1. INTRODUCTION TO TECHNOLOGY

Picarro analyzers use time-based, optical absorption spectroscopy of the target gases to determine concentration in a sample. They are based on wavelength-scanned cavity ring-down spectroscopy (WS-CRDS), a technology in which light travels many times through the sample, creating a very long effective path length for the light to interact with the target gas, thus enabling excellent detection sensitivity in a compact and rugged instrument.

The Picarro analyzer is comprised of two modules:

- The **Analyzer** contains the spectrometer, sample chamber, and a computer with a hard drive to store and analyze data. The single analyzer module controls the operation of the system and converts spectroscopic measurements into gas concentration data.
- The **External Vacuum Pump** draws the sample gas through the instrument.

1.1 Cavity Ring-Down Spectroscopy (CRDS)

Nearly every small gas-phase molecule (e.g., CO₂, H₂O, H₂S, NH₃) and isotopologue (e.g., H₂¹⁸O, ¹³CO₂, ¹⁵N¹⁴N¹⁶O) uniquely absorb specific wavelengths of near-infrared light. The strength of the light absorption is related to the concentration of a molecule in a sample and the distance that light travels through the sample, called the path length.

Conventional infrared spectrometers are typically only sensitive enough to detect trace gases at levels in the part-per-million. Cavity Ring-Down Spectroscopy (CRDS), on the other hand, is one thousand to one million more times sensitive.

In Picarro analyzers, light from a single-frequency laser enters a cavity where three mirrors reflect the laser light as seen in Figure 1. The light enters through the mirror closest to the laser, bounces off the angled mirror in the lower right corner of the cavity, travels to the hemispherical mirror at the top of the cavity, bounces toward the mirror in the lower left corner of the cavity, and then returns to the first mirror. This motion becomes a continuous traveling light wave, which is represented by the dark orange path in Figure 1.

Figure 1:
Schematic of
the Picarro
CRDS analyzer
cavity

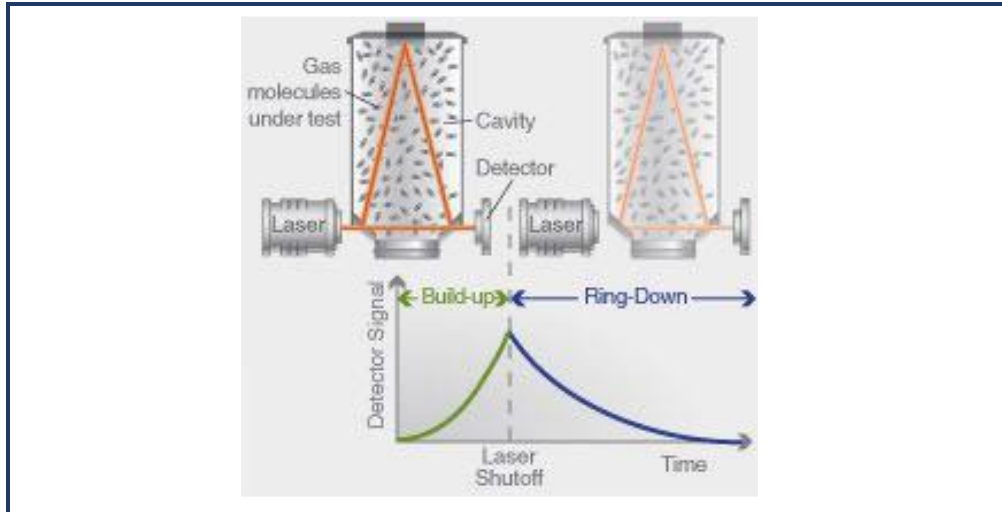

When the laser is on, the cavity quickly fills with laser light. A small amount of the laser light is transmitted through the mirror closest to the photodetector, which turns the incident light into a signal that is directly proportional to the light intensity in the cavity.

When the photodetector signal reaches a threshold level (in a few tens of microseconds), the laser is turned off. The light contained within the cavity continues to bounce between the mirrors (about 40,000 times). Since the mirrors have slightly less than 100% reflectivity (99.999%), the light inside the cavity steadily leaks out of the cavity. The intensity of the light reaching the detector decreases, falling exponentially until it reaches zero. This decay, or "ring-down," is measured in real time by the photodetector.

1.2 Relating ring-down time to absorption intensity

The time it takes to ring-down is inversely related to the total optical loss in the cavity, including the strength of molecular absorption at a given wavelength of light. For an empty cavity, the time it takes for the intensity to decrease by a given percent is determined solely by the reflectivity of the mirrors. A cavity containing gas that absorbs light will have a shorter ring-down time than an empty cavity. As the light circulates in a cavity with a gas sample, the molecular absorption by the gas results in a decrease of the light intensity.

Determining absorption intensity at a specific wavelength requires comparing the ring-down time of an empty cavity to the ring-down time of a cavity that contains gas. Picarro instruments gather measurements from an "empty" cavity by switching the light to wavelengths that are not absorbed by the target molecules. The analyzer subsequently measures ring-down

times at wavelengths that are absorbed by the target gas. The analyzer automatically and continuously compares these two types of ring-down times, and the software uses those comparisons to calculate absorption intensities.

Figure 2:
Light intensity
as a function of
time in a CRDS
system



1.3 Converting absorption intensity to concentration

Plotting the absorbance at each measured wavelength generates an optical spectrum. This spectrum contains absorbance peaks that are unique to each molecule in the sample. The height of a particular absorption peak is proportional to the concentration of a molecule that generated the signal.

The height of the peak is calculated by subtracting the maximal absorbance from the baseline absorbance. Figure 3 shows a plot of ideal optical spectra with a clean, uniform baseline on either side of the absorption peak.

Figure 3:
Absorption
Spectral Curve

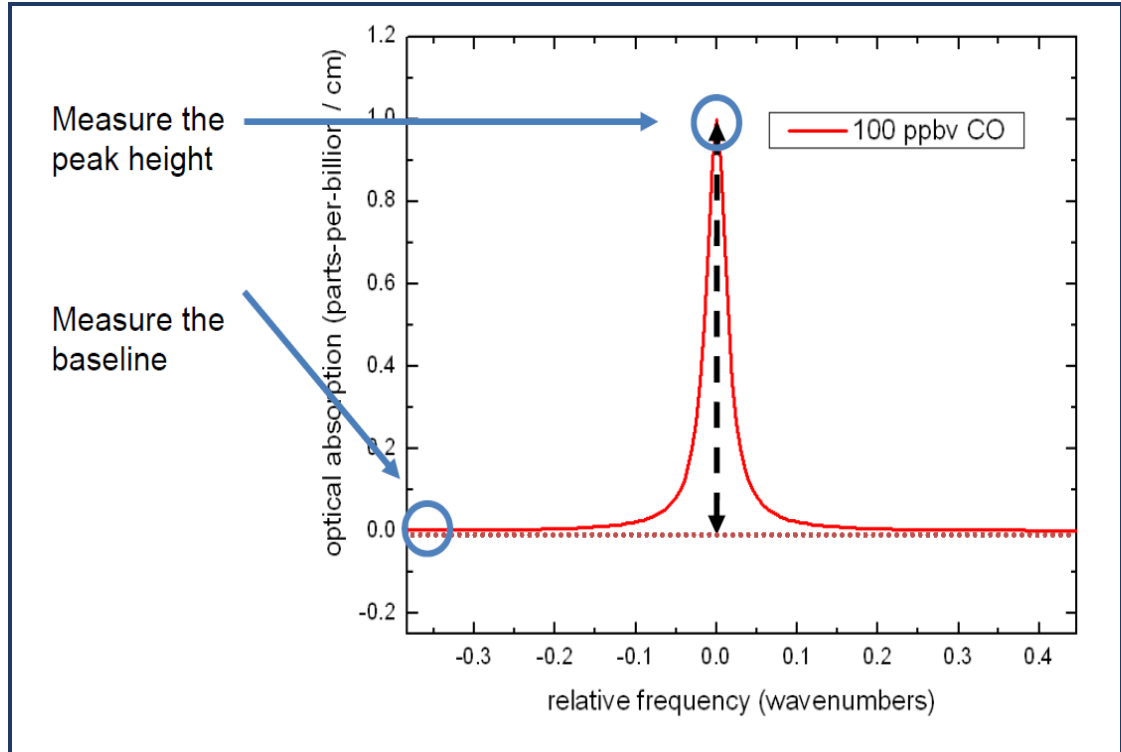

Optical spectra often contain several absorption lines, nested closely together. A particular absorption peak may be visible between lines, but the absorption may not return to the baseline before it rises in response to another molecule. Picarro analyzers calculate the baseline underneath a poorly resolved peak by modeling the absorption peaks from other surrounding molecules and subtracting contributions from neighboring peaks to the absorption intensity.

1.4 Spectral precision and high sensitivity measurements

Picarro analyzers contain two features that provide high spectral precision:

- A proprietary **wavelength monitor (WLM)** that measures the absolute laser wavelength to a precision that is a few orders of magnitude narrower than the spectral linewidth: Picarro's patented WLM measures absolute laser wavelength to a precision more than 1,000 times narrower than the observed Doppler-broadened linewidth for small gas-phase molecules. The instruments lock the laser to the WLM, and then the monitor tunes to wavelengths known to be maximally and minimally absorbed by the target molecule. The result is closely clustered absorption intensities at and around the wavelength of peak absorption.
- Precise **temperature and pressure control** in the sample cavity: Accurate absorption measurements at precisely known wavelengths







account for little unless the temperature and pressure of the CRDS measurement cavity are known. The observed line intensity and shape depend on the temperature and pressure inside the sample cavity. To completely minimize instrument measurement drift, temperature and pressure must be actively stabilized to constant values.

For precise temperature control, the sample cavity is surrounded by layers of thermally insulating material to provide a high degree of passive thermal stability. The cavity is further actively stabilized by means of a solid-state heating system locked to the output of a thermal sensor. This enables the temperature of the cavity to be within 20 mK of the set temperature.

For precise pressure control, the cavity pressure is monitored using a high-linearity pressure transducer. The system computer uses this pressure data in a feedback loop to control proportional valves that adjust the inlet and outlet gas flow of the cavity.

2. CONVENTIONS

The following icons are used throughout this manual to emphasize important information in the text. These icons indicate dangers to either the operator or to the analyzer, and other important information.

	<p>Consult the user's manual for important information (When you see this symbol placed at hazard points on equipment, consult the user manual).</p>
	<p>NOTE is important information that you should be aware of before proceeding.</p>
 <p>WARNING</p>	<p>LASER WARNING alerts you of a laser danger.</p>
 <p>CAUTION</p>	<p>CAUTION alerts you of a potential danger to equipment or to the user.</p>
 <p>WARNING</p>	<p>WARNING indicates an imminent danger to the user.</p>
 <p>REMINDER</p>	<p>REMINDER is a helpful hint to procedures listed in the text.</p>

3. ACRONYMS

This manual includes various acronyms. For definitions, see below:

Acronym	Definition
CRDS	Cavity Ring-Down Spectroscopy
GUI	Graphical User Interface
cm	centimeters
mm	millimeters
" (as in 1/4")	Inches
NH ₃	Ammonia
H ₂ O	Water
HB	Hotbox
WB	Warm box
ppm	Parts Per Million
ppb	Parts Per Billion
‰	per mil
°C	degrees Celsius

4. SAFETY

4.1 General Safety

CDRH Certification

This Picarro Analyzer complies with 21 CFR Chapter 1, sub-chapter J, and is classified as a Class 1 laser system when all panels and covers are on.

CE Certification

This Picarro Analyzer complies with the European standards and the instrument is affixed with a CE label. This CE label is located on the rear of the instrument.



WARNING

Using this analyzer in a manner not specified by Picarro may result in damage to the analyzer, and render it unsafe to operate.



WARNING

This analyzer is for indoor use only and has an ingress protection rating of IPx-0. Analyzer is NOT protected against exposure to water including dripping, spraying, splashing or immersion.



WARNING

Do not operate in an explosive atmosphere! Do not operate in the presence of flammable gases or fumes.



CAUTION

The analyzer contains no user serviceable components except the particulate filter, fans, and the vacuum pump. Do not attempt repairs; instead, report all problems to Picarro Customer Service or your local distributor. Please contact Picarro if you have any questions regarding the safe operation of this equipment.



CAUTION

The inlet gas connector on the back panel of the Analyzer, and its immediate vicinity, runs hot during operation of the analyzer. Take care when connecting gas lines or working at the rear of the instrument to wear protective gloves or avoid contact with these surfaces.



WARNING

This analyzer weighs 46 lbs. (20.9 kg). Use the technique described below when lifting the analyzer.

- a. Before lifting, inspect the unit for slippery substances or sharp edges.
- b. Lift with two people, one on each side of the analyzer.
- c. Crouch down and stay close to the unit. Always keep your back as straight as possible.
- d. Position your feet for sturdy balance. Lift with your legs, not your back.
- e. Do not twist the back while carrying the unit. Rotate direction with hip joints.
- f. Lower the unit by bending at the knees.

4.2 Laser Safety



WARNING

This equipment is classified as a Class 1 laser product with an embedded 3B laser in accordance with EN 60825-1:2014. Do not to open the enclosure where this label is placed; there are no user serviceable parts inside.

The following Laser Safety Label is affixed to the outer cover of the analyzer.



WARNING

The laser is a Class3B when exposed. Only operate or service this device in accordance with the instructions in this guide, and only open the device in an approved laser safe service area using appropriate laser-safety glasses.

The following **Laser Safety Label** is affixed to the inside of the analyzer:

Figure 4:
Laser Safety
Label



WARNING

Use of controls or adjustments or performance of procedures other than those specified herein may result in hazardous radiation exposure.

5. UNPACKING THE ANALYZER

5.1 Inspect the Shipping Boxes

Picarro products are inspected and tested before leaving the factory. Their packing containers have been designed to keep the equipment safe from damage during transit.

Inspect the condition of the boxes upon arrival. The larger box includes the analyzer and most of the accessories. Even if the outer box shows damage, the inner box holding the analyzer is cushioned enough that it will protect the instrument under most circumstances.

If the equipment does appear to be damaged, photograph the damages and contact Picarro (email pictures if possible) as soon as possible.

5.2 Unpack the Shipping Boxes

This section describes the contents of the shipping boxes:

- Inspect each item to ensure it is not damaged.
- If items are missing, contact Picarro.
- Keep the shipping packages to reuse when transporting the analyzer.
- Contact Picarro for options on transporting systems to remote labs.



This analyzer weighs 46 lbs. (20.9 kg). Use the technique outlined in the General Safety section on page 14 when lifting or moving the analyzer.

Figure 4:
Box Contents

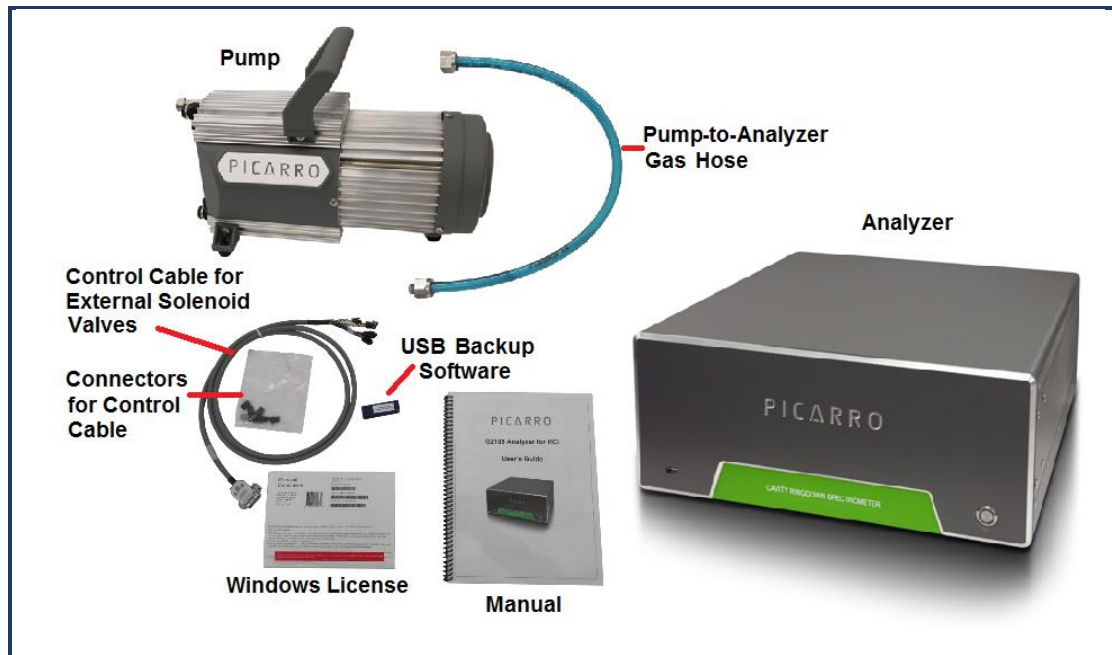

Box One: Analyzer and Accessories

Item (qty)	Description
Analyzer (1)	Includes all the data acquisition, control, and communications hardware and firmware to perform all gas handling, spectral collection and analysis.
A/C Power Cables (1)	A power cable with connectors appropriate to your country is provided. The analyzer automatically adjusts to local voltage.
Keyboard (1)	USB keyboard
Mouse (1)	USB mouse
Control Cable (1)	For External Solenoid Valves
Nut (1) and Ferrules (2)	For connecting input line to analyzer INPUT
Document Packet (1)	Includes this manual, certificate of compliance, and Windows License.
USB Flash Drive	Contains backup software.

Box Two: Vacuum Pump and Accessories

Item (qty)	Description
Pump (1)	Provides vacuum required for sample gas sequencing into and out of the analyzer.
A/C Power Cable (1)	A power cable with connectors appropriate to your country is provided.
Vacuum Hose (1)	Hose to connect the pump to the analyzer.
Pump Manual (1)	Detailed instructions for pump.

6. ANALYZER OVERVIEW

6.1 Intended Use

The G2123 Analyzer measures concentrations of NH₃, and H₂O simultaneously and precisely using Picarro's patented Cavity Ring-Down Spectroscopy (CRDS) technology. The analyzer can be deployed in a lab or in the field, allowing in-situ analysis for trace ammonia or ambient ammonia monitoring applications.

6.2 External Vacuum Pump

The external vacuum pump is used to maintain cavity pressure inside the analyzer. The pump should be connected and running whenever the analyzer is in use.

Figure 5:
External
vacuum pump

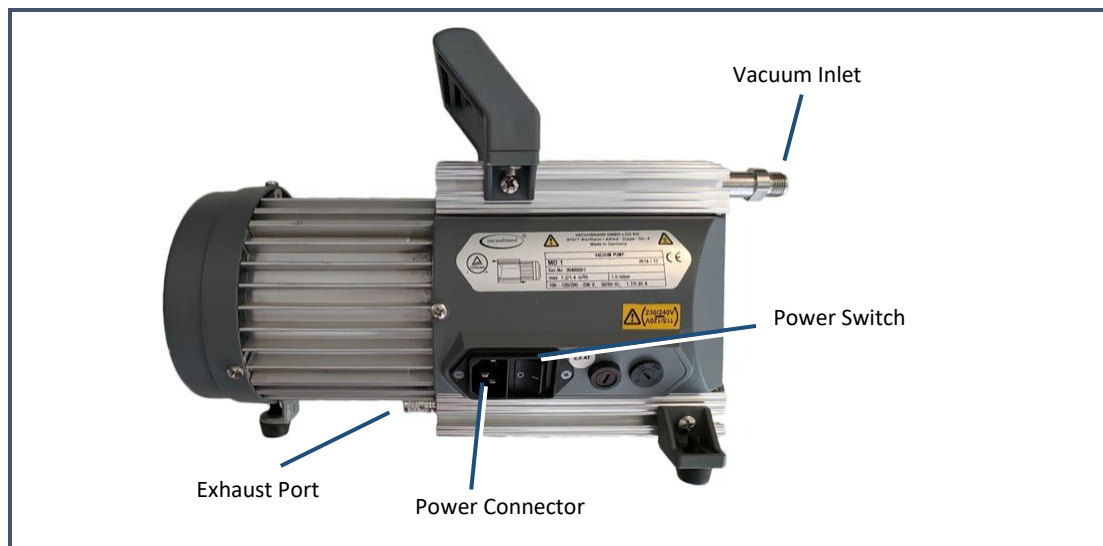

6.3 Analyzer Specifications

Weight (Total)	60.4 lbs. (27.4 kg), Including external pump
Analyzer	46 lbs. (20.9 kg)
Pump	14.4 lbs. (6.5 kg)
Analyzer Dimensions	Length: 17.55" (43.2 cm) Width: 17" (44.6 cm) Height: 7" (17.8 cm)
Temperature Range	Storage: 0 °C to 70 °C; Operation: 10 °C to 35 °C
Sample Flowrate	<1.5 slm at 760 torr (101 kPa)
Ambient Humidity Range	<85% R.H. non-condensing
Maximum Altitude	10,000 ft. (operation)
Clearance	Front: 6" (15.3 cm); Rear: 6" (15.3 cm)
Power Requirements	100 to 240 VAC; 47 to 63 Hz (auto-sensing)
Startup Power	<375 W at start-up (Analyzer and Pump)
Steady-state Power	120 W (Analyzer), 150 W (Pump) Steady-state operation
Mains Supply Voltage Fluctuation	±10% of the nominal voltage
Minimum Rated Circuit Amperage	10 A @115 VAC 5 A @230 VAC
Liquid Ingress Protection	None

7. INSTALLATION

This section describes the setup and installation of the Picarro Analyzer. Please read and understand this section thoroughly before proceeding with the installation.



WARNING

Using this analyzer in a manner not specified by Picarro may result in damage to the analyzer and render it unsafe to operate.



WARNING

Do not attach electrical power to, or start the analyzer until *after* attaching and turning on the External Vacuum Pump. Do not disconnect the vacuum line while the analyzer is running. Failure to do so could result in damage to the optics.



WARNING

Picarro sells USB enabled devices, such as GPS, which is approved for use. Please do not connect USB hubs or unapproved USB devices, other than flash drives to the computer because they can interfere with the operation of the analyzer.



WARNING

If rack mounted, the Analyzer cannot support itself using a front rack mount kit alone. The instrument *must* be supported by a shelf or additional rails attached to the rack.



CAUTION

If the analyzer has been stored at less than 10 °C, allow the components to equalize to room temperature before starting the installation process.



CAUTION

Analyzer is for indoor use only and has an ingress protection rating of IPx-0. Analyzer is NOT protected against exposure to water including dripping, spraying, splashing or immersion.



CAUTION

During installation and operation, do not position the analyzer so that it is difficult to operate the disconnecting device.



CAUTION

When the analyzer is being integrated to an external system, the safety of that system is the responsibility of the assembler of that system.



NOTE

Take care to ensure that warm air is exhausted from an enclosure in which the analyzer is mounted.



CAUTION

It is imperative that the analyzer have adequate ventilation and/or cooling to maintain the ambient temperature below 35 °C when operating. Failure to provide adequate airflow, especially clearance at the front and rear panels, to ensure proper airflow and/or cooling to the analyzer will result in overheating of the analyzer causing a shutdown and potential damage. There should be 4" (10cm) of clearance in the front and back of the analyzer.

Thermal Specifications	Min	Max	Description
Ambient Operating Temperature	10 °C	35 °C	Worst-case environmental limits (unless otherwise specified)

7.1 Analyzer and Vacuum Setup

1. Remove the Analyzer and the External Vacuum Pump from their respective shipping containers.



WARNING

This analyzer weighs 46 lbs. (20.9 kg). Use the technique outlined in the General Safety section on page 14 when lifting or moving the analyzer.

2. Place the Analyzer on a bench top or flat surface. Place the External Vacuum Pump near-by or on the floor. Don't push the

analyzer into position yet, there are cables to be installed on the back panel.

3. Unpack the analyzer accessories. The Certificate of Compliance and USB drive should be stored in a safe place and may be required if you contact Picarro with questions about your analyzer.
4. Remove the caps from the analyzer's INLET and VACUUM connection ports. Save the caps; you should reinstall them when the analyzer is stored, moved or shipped.
5. Remove the cap from vacuum pump's inlet. Save the cap for later use. Reinstall the caps when the pump is stored, moved or shipped.
6. Connect one end of the vacuum hose to the pump: hand tighten the nut and then use an 11/16" wrench (not included) to make an additional turn of one flat (about 60 degrees).
7. Connect the analyzer to a power source using the supplied AC power cable.



CAUTION

Use the AC power cables supplied with the analyzer or a similarly rated cable. Check with Picarro technical support if you have questions about power cable replacement. An inadequately rated power cable can result in equipment damage.



CAUTION

Cords shall be RATED for the maximum current for the equipment and the cable used shall meet the requirements of IEC 60227 or IEC 60245. Cords certified or approved by a recognized testing authority are regarded as meeting this requirement. The connector type used should be: IEC320 C13.

8. If desired, attach a tube to the External Vacuum Pump exhaust port and direct to a safe place for venting the mixture of sample gases.
9. Select the appropriate voltage, 110V or 220V, for the External Vacuum Pump using the Power Switch located on the pump.
10. Connect the External Vacuum Pump to a power source using the other AC power cable.

Figure 6:
Analyzer Back Panel

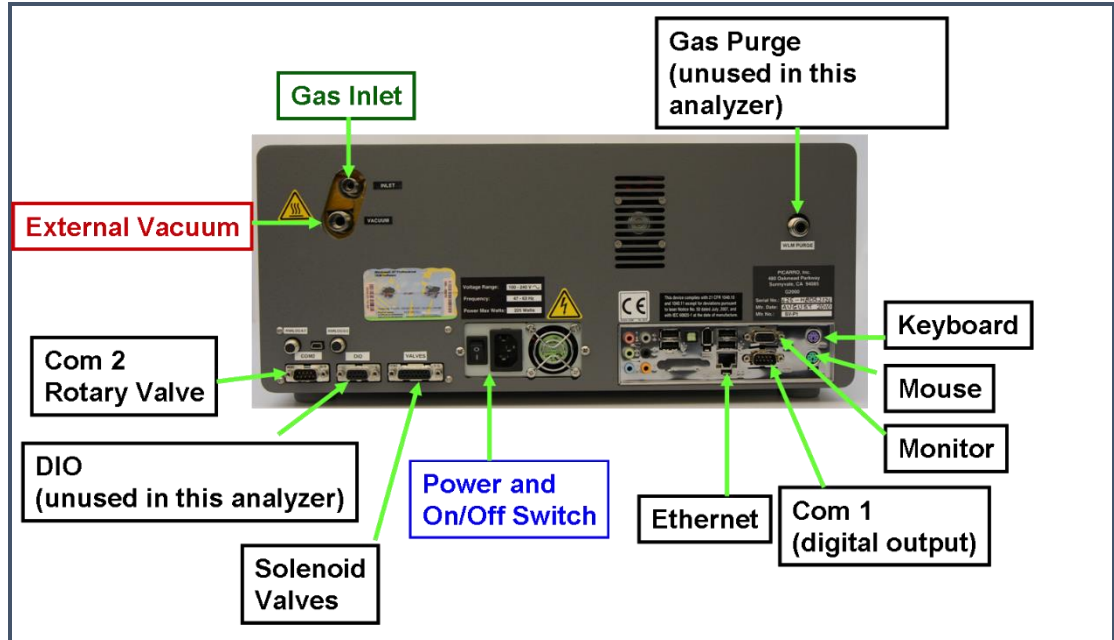

NOTE

The software to operate the instrument will start automatically after the operating system has loaded. The user interface will appear a few seconds after the instrument software starts. See Section 8.1 on Page 25.

7.2 Connecting to the Analyzer Inlet

Connect to the inlet of the analyzer using ¼" OD PTFE or PFA tubing using the supplied plastic ¼" PFA inlet nut and ferrules.



WARNING

When using compressed gases, follow all appropriate safety conventions, including use of eye protection, physical restraint of cylinders, etc.

Making a new connection:

When using new tubing, follow these steps.

1. Place the two ferrules inside the nut as shown.

Figure 7:
Orientation of ferrules and nut



2. Loosely connect the nut to the INLET on the back panel of the analyzer about a full turn, being careful not to let the ferrules fall out.
3. Insert the tubing into the back of the nut, feeding it in as far as possible without deforming the tubing.
4. Hand tighten the nut.
5. Using a 5/8" wrench (not included), tighten the nut approximately seven flats (420 degrees).

Replacing a connection

When reattaching tubing that already has a nut connected:

1. Inspect ferrules. If you see any damage, replace the ferrules and follow the directions above for making a new connection.
2. If there is no damage, hand tighten the connector to the analyzer's INLET.
3. Using a 5/8" wrench (not included), tighten the nut approximately one flat (60 degrees).

7.3 Setting Up a Monitor, Keyboard, and Mouse

A video monitor (not included), keyboard, and mouse are required for monitoring device operations, viewing or changing settings (including setting user permissions), or validating device performance.



NOTE

This device will operate under its default settings without any direct control of the internal software.

1. Connect a keyboard to one of the available USB ports.
2. Connect a mouse to one of the available USB ports.
3. Connect a monitor to one of the monitor ports. The analyzer will detect the connection and adjust the resolution to match the monitor.
4. Connect the monitor to a power source.
5. Turn on power to the monitor.

8. ANALYZER BASIC OPERATION

8.1 Startup Procedure

This section describes the steps to power on the system. These steps are sufficient for operating the instrument. For Shutdown Procedure, see Section 8.3.



CAUTION

Always turn on the external pump before turning on the analyzer.

1. Switch on the external vacuum pump.
 2. Switch on the main power to the analyzer.
 3. Press the soft power button located on the front panel. The software will start automatically and the analyzer will display the CRDS Data Viewer window. Data Viewer features are detailed in Section 9.
 4. Wait approximately 45 minutes for the system to power, initialize, and stabilize.
 5. Once the cavity pressure and operating temperature are at their proper setpoints and stable, the analyzer will start measuring.
-



NOTE

As the instrument is starting up, it is normal for there to be a delay in reporting data. This can take several minutes depending on how long it takes for the internal temperature and pressure to reach their operating points, and it is normal during this time for some concentration readings to be negative or constant. The pull-down menus in the Data Viewer will not be populated until actual data is being reported. This is typically within less than 30 minutes from startup, but can take up to 1 hour to stabilize depending on ambient temperature.

Figure 8:
Picarro
Analyzer GUI
The heading may vary depending on the analyzer type.

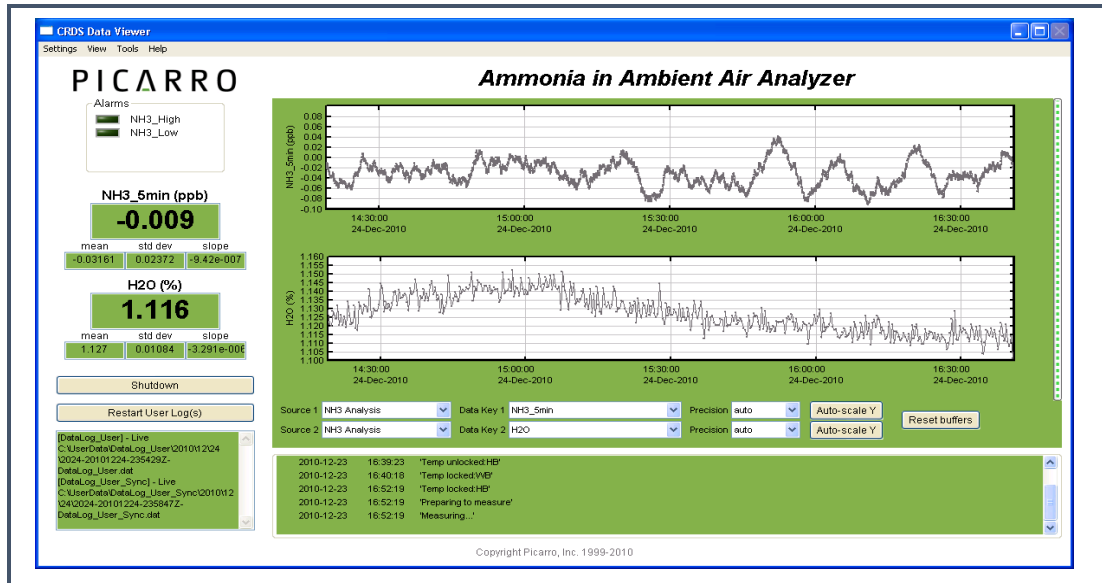

8.2 Desktop Icons and Folders

On the Windows™ desktop, there will be the following icons and folders:

1. **Start Instrument:** When clicked, the analyzer will start measuring in the configuration that it was in when the software/analyzer was shut down.
2. **Coordinator Launcher:** Depending on the system's configuration, the coordinator program may not be included. Clicking on this icon will lead you to a window that will allow you to choose the proper coordinator to operate the peripheral module that came with your analyzer.
3. **Picarro Mode Switcher:** When clicked, you will be led to a window that will allow you to switch between various measurement modes. Most analyzer models are configured for one mode and may not include the Mode Switcher. If the analyzer has multiple modes, this allows the user to switch between them easily.
4. **Picarro Controller:** When clicked, you will be led to a useful diagnostic panel allowing the user to see the analyzer's internal temperatures, pressure, and spectroscopy in real time. This program has user-accessible functions, but it cannot change anything related to analyzer functionality. It is intended for diagnostic purposes only.
5. **Picarro Utilities Folders:**
 - i. **Data file Viewer:** When clicked, you will be led to a window that will allow you to convert between *.dat and H5 data files

and to make various graphical representations of your data. The instructions on using the Data File Viewer software are described in the Appendix B

- ii. **Data Recal:** When clicked, you will be led to a window that will allow you to recalibrate your data based on known, certified data.
- iii. **Setup Tools:** When clicked, you will be led to a window that will allow you to edit various settings for your analyzer (See the Setup Tools section of this manual for information about these settings).

6. Diagnostic Folder

- i. **Stop Instrument:** When clicked, you will be led to a window that will allow you to turn off the analyzer in an emergency event. Upon clicking on this icon, the following window will pop up. Please see **Shutdown Procedure** on page 29 of this manual to shut down the analyzer in normal circumstances.

Figure 9:
Stop CRDS
Software



CAUTION

EXCEEDING GAS INLET PRESSURE OR TEMPERATURE SPECIFICATIONS COULD RESULT IN DAMAGE TO THE INSTRUMENT. In the case of higher input pressure or flow, configuring a sampling bypass manifold system is recommended.

Use a 'tee' at the gas inlet and either return the remainder to the main gas stream or exhaust appropriately.



CAUTION

Do not disconnect the AC power to the analyzer, vacuum line or the AC power to the External Vacuum Pump while analyzer is operating. Damage may be caused by current surges if power is applied while attaching or removing cables.

8.3 Shutdown Procedure

To shut down the analyzer using the GUI:

1. Click on the “Shutdown” button located on the left side of the Data Viewer window.
2. A window will pop-up prompting the user to confirm the shutdown. Once confirmed, the analyzer software and hardware will begin shutting down.
3. Once the hardware has completed shutdown, manually turn off the pump(s) and dry gas (only if your system requires it).

Figure 10:
Shutdown
Window

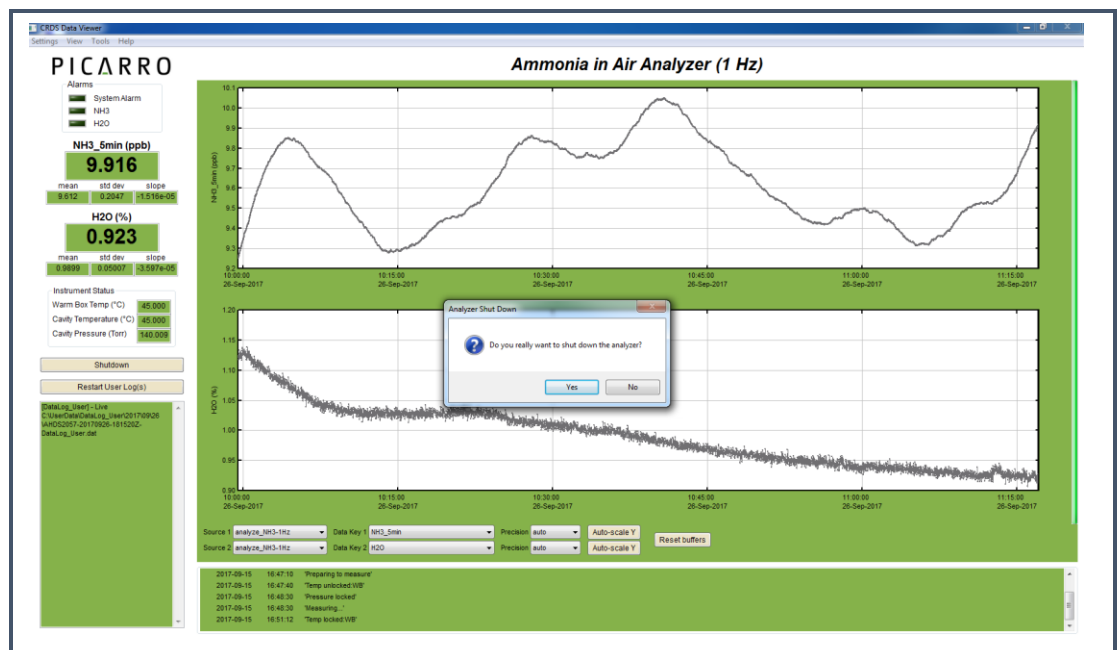

CAUTION

A flow of clean, dry gas should always be directed to the instrument for several minutes prior to shutting down. Trapping a high-moisture content gas sample in the cavity can cause condensation damage to the mirrors as the instrument cools from its operating temperature.



CAUTION

Do not turn off the pump or disconnect the vacuum line while the instrument is operating.



FOR G2xxxx ANALYZERS: If you have trouble turning off the analyzer software, do not kill the process(es) in the task manager; rather, double-click on the "Stop Instrument" icon in the Diagnostics folder on your desktop.

8.4 In case of an Electrical Power Outage

If the power to the analyzer is cut-off for any reason, the analyzer will cease operation. However, when the power is reapplied, the analyzer will restart automatically. The Picarro software tools will also properly close out previous files and open new files for data collection so that previously collected data, instrument diagnostics, and other parameters recorded up to the time of power outage are retained.

If short power outages will be a routine occurrence in your operating environment, Picarro recommends the use of an uninterrupted power supply to prevent damaging the hardware or software.

9. LIST OF GUI FUNCTIONS

9.1 GUI Overview

The features of the Picarro analyzer GUI are identified in Figure 11 and described in the following sections.

Figure 11:
Layout of the
G2123 Analyzer
GUI

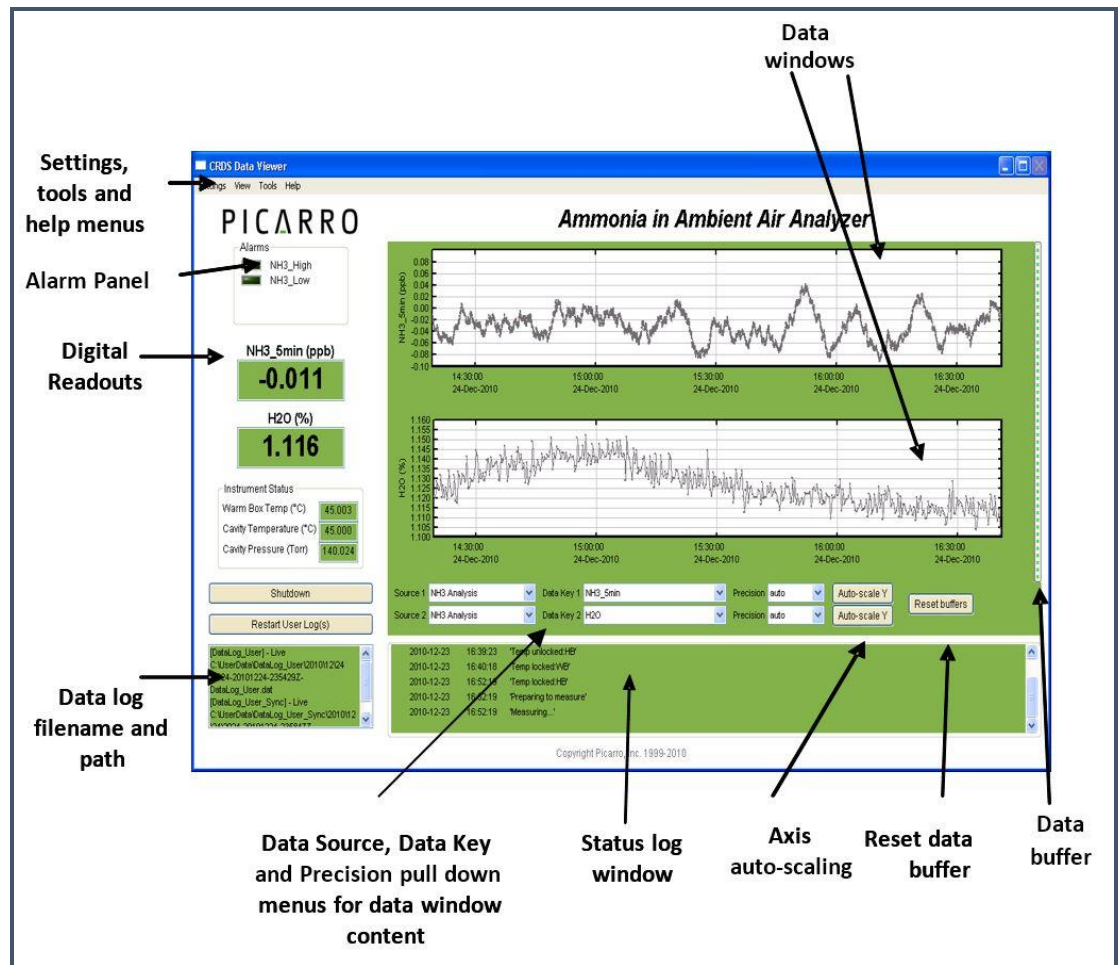

9.2 Settings, Tools, and Help Menus

Precision Pulldown Menu

Left clicking on the Settings menu pulls down a menu that has one entry 'Change GUI Mode from Standard to Service.' This is the access point to a password protected service mode where additional operational and measurement parameters are displayed. Selecting and clicking on this

entry opens the Cavity Ring-Down Spectrometer Controller. This is reserved for Picarro service operators only.

View Menu

This menu item has three entries:

1. Lock/Unlock time axis when zoomed: When locked, forces the two graphs to display the same time scale during zoom.
2. Show/hide statistics: Toggles the measurement statistics display, see **Digital Readouts** below.
3. Show/hide instrument status: Toggles the status of the instrument display. See
4. Instrument Status below.

Tools Menu

This menu item has three entries:

1. **User Calibration:** Opens the user calibration window (default password is “picarro”). The password can be reset in the *QuickGui.ini* file in the instrument directory *C:\Picarro\G2000\AppConfig\Config\QuickGUI* under the section [Authorization] UserCalPassword = Picarro Show/Hide Valve
2. **Sequencer GUI:** Toggles the display of the external valve sequencer window.
3. The calibration slope and intercept can be entered and their effects immediately were seen in the data. Please refer to the Calibration Section on page 49.

Help Menu

1. **About:** Displays the version number of the instrument.

9.3 Alarm Panel

This panel is used to monitor the status of the internal instrument alarms. These indicators are gas concentration alarms, such as “NH₃ Too High/Low” depending on instrument configuration. The gas concentration alarm LEDs are off (grayed) when the respective concentrations are below a certain value, and they are illuminated when the respective concentrations are above/below a certain value. To view the alarm set point, click on the LED and a dialog box will appear indicating the alarm setting and allow the user to enable it or change the setpoint:

Figure 12:
Alarm Setting
Window

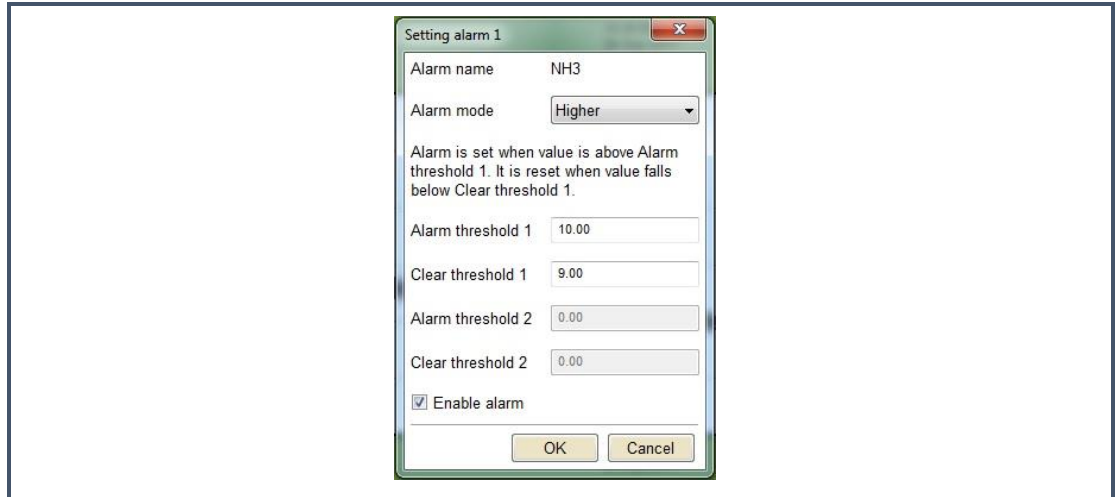

Type the value you wish to set the alarm to and press the “OK” button, or press “Cancel” if you do not wish to change the alarm value. If you do nothing, the dialog box will disappear and the alarm value will remain unchanged.

9.4 Instrument status

If these parameters are enabled through the ‘Show Instrument Status’ entry in the ‘View’ Menu on the main toolbar digital readouts for Warm Box temperature, Cavity Temperature and Cavity Pressure are displayed to the left of the main trend graphs.

Figure 13:
Instrument
Status

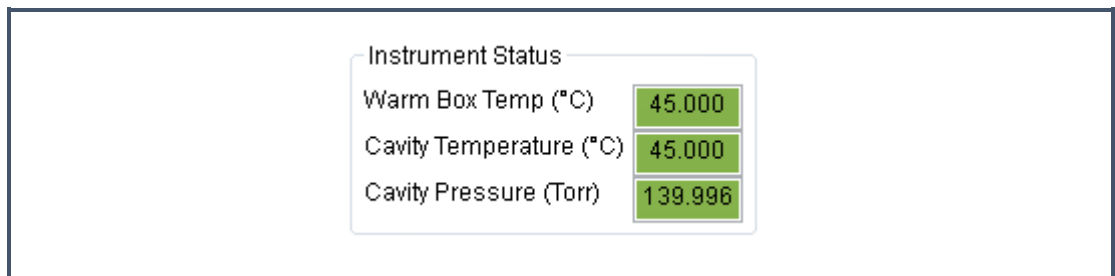

9.5 Data Log Filename and Path

The filename and path of the active data log are displayed in this pan. The indicator is grayed-out if there is no active data log (i.e., if a new data log has not been started using the *Start /Stop New Data Log Button*). A new file will be generated at midnight, which will be saved to the same location as the original log file.

Figure 14:
Data Log
Filename

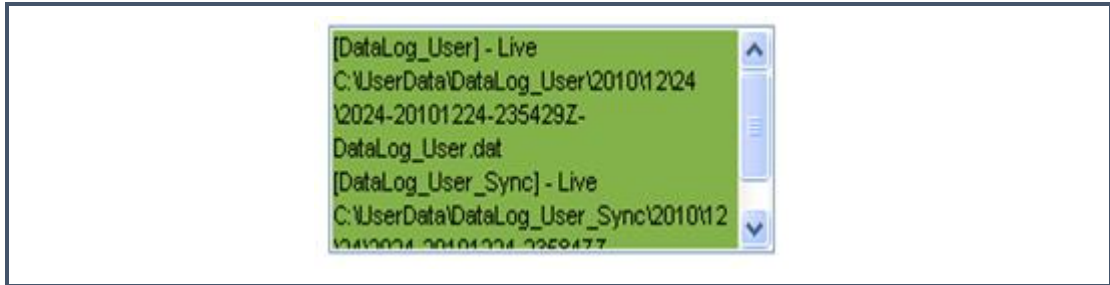

9.6 Data Window

The data window displays a graph of any stream of data vs. system time, with a format of hh: mm: ss. The user can select which data stream is displayed using combinations from the Data Source and Data Key pull-down menus. The precision displayed can be adjusted using the “Precision” menu and Auto-scaling of the ‘Y’ axis is also available.

Figure 15:
Data
Window

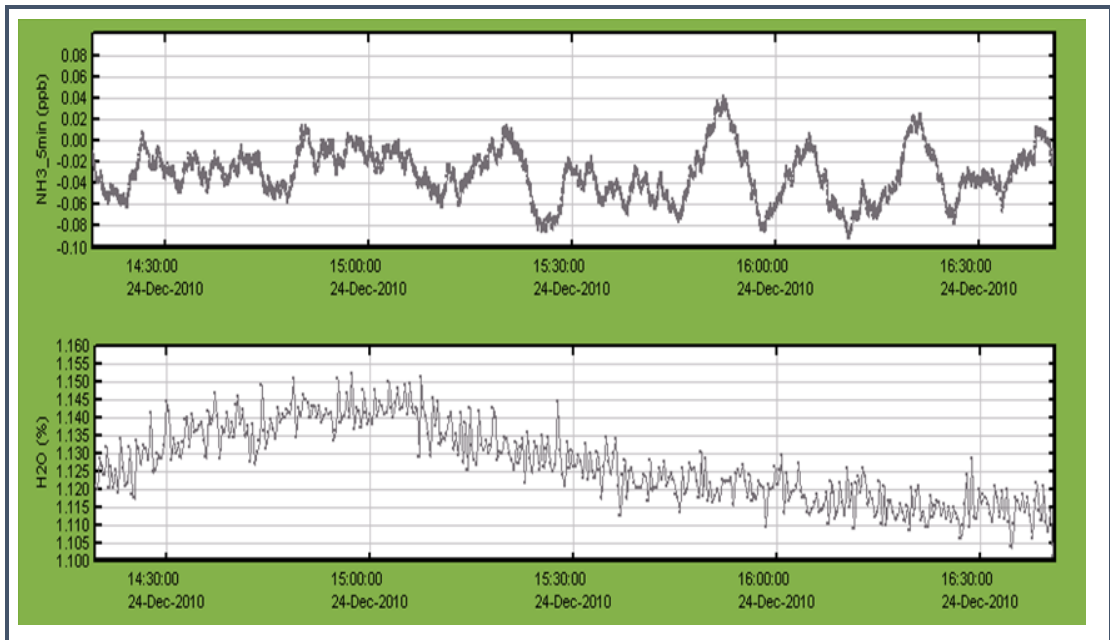

Data Source and Data Key Pull Down Menus

These two menus enable selection of the data stream that is viewed in the *data window*. Data streams available on the GUI are gas concentrations, if ‘*instrument Analysis*’ (where *instrument* represents the system installed) is selected, or if “sensors” is selected, the analyzer’s optical cavity pressure or temperature can be viewed as well as the nominal ambient temperature of the analyzer (“DAS temp”) and the temperature of the analyzer’s electronics chamber, indicated as “warm chamber temp.”

Figure 16:
Data Source

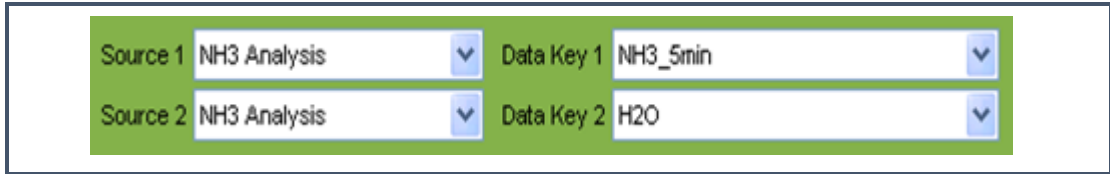

Precision Pulldown Menu

Click on this icon to select the precision displayed on the y-axis, between 0 and 4 digits of precision or “auto.” The currently selected precision is displayed during operation. This does not affect the precision of the saved data in the data log files or results files.

Figure 17:
Precision Pulldown

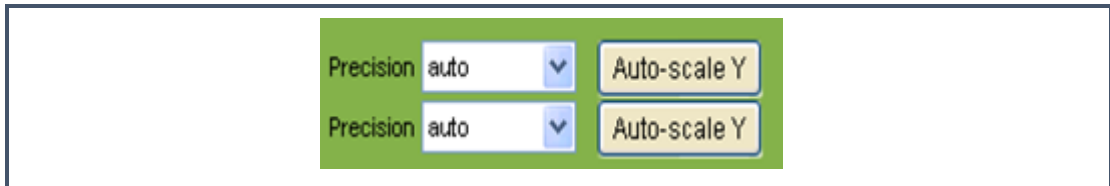

Data Buffer Level Meter

The meter to the right of the *Data Window* indicates how much of the internal memory of the GUI is used to retain historical data collected with the instrument. There is an internal limit of a finite number of points. Once that number of data points is collected, the buffer is full, and old data is removed from the buffer as new data is collected. This buffer affects only the data displayed in the data window, not the data stored in any files. This buffer is empty upon instrument startup, and can also be emptied by pressing the reset data buffer button in the lower-right-hand corner of the GUI.

Figure 18:
Data Buffer and Reset Buffer

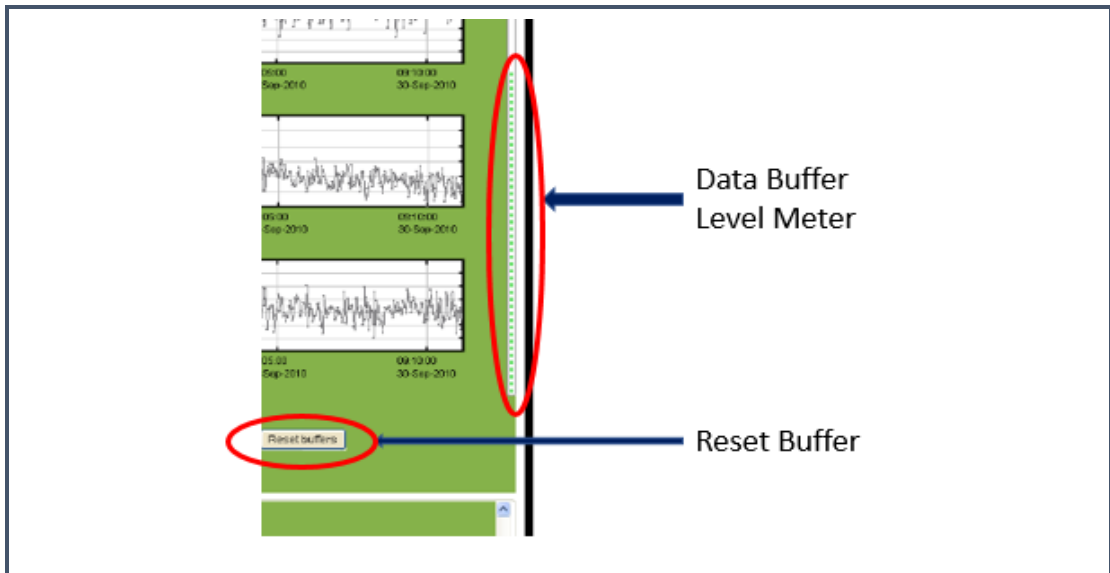

Reset Data Buffer Button

Press this button to clear the internal data buffer of the GUI (this clears the current data traces from the graphs). This has the effect of clearing all data in the data window. Pressing this button has no effect on any of the data log files stored by the instrument.

Graph Zooming

To zoom the graph, simply drag the magnifying glass over the section to be zoomed and click and hold the left mouse button. While holding down the left button, move the mouse to create a box that covers the region of interest. When the box is properly drawn, release the left button and boxed area will automatically scale to fill the data window. To zoom back out, double-click on the left button. To auto scale, the y-axis of either graph, use the auto-scale buttons below the graph. To lock or unlock the time axis of each graph during zooming, select that menu item in the 'View' menu.

Figure 19:
Graph
Zooming

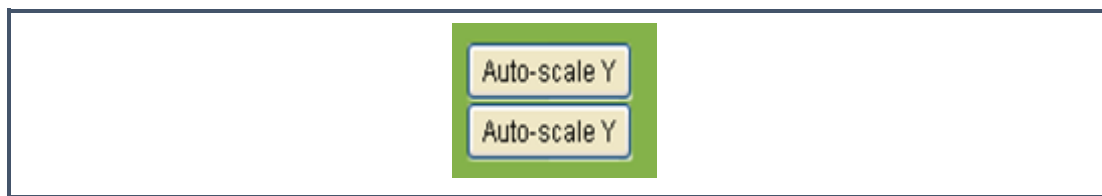

Digital Readouts

Displays the latest value recorded for the selected Data Key for each Data Window. Changing the Data Key modifies the Digital Readout as well as the Data Window view. If the 'Show Statistics' entry is enabled in the 'View' menu, the mean, standard deviation and slope of the data in the graph are dynamically calculated and indicated below the digital concentration readout. These numbers change to reflect statistics of whatever data is in the data window.

Figure 20:
Digital
Readout

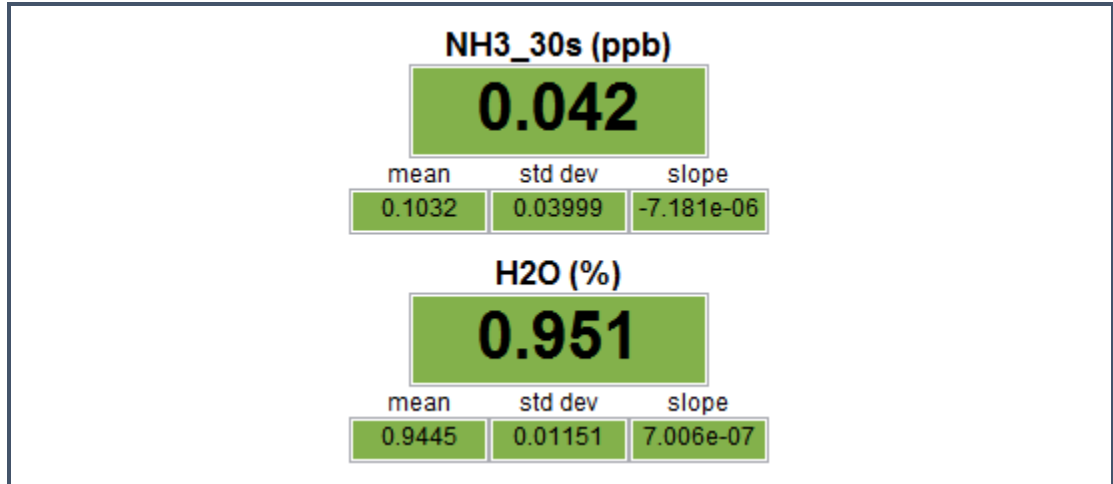

Start / Stop Data Log Button

The Analyzer automatically records all data collected on the instrument and saves it for later analysis. These files are called Data.dat files, which are described below in the section called **File Management**. In addition, the user can record a separate data log file. Press this button if you would like the instrument to start recording a separate data file. A dialog box will appear prompting you for a filename and location. Press this button again to stop recording the data file.

9.7 Status Log Window

This window displays instrument status messages, in the following form: “MM/DD/YYYY hh: mm: ss generic message text.” These messages include all messages sent to the DAS front panel display. The common status log messages are:

1. *Temperature Locked: WB (HB)*

The system waits for the warm box (“WB” – the temperature-controlled electronics and wavelength monitor chamber) to reach operating temperature. Similarly, the temperature of the hot box (“HB” – the temperature-controlled chamber containing the analyzer’s optical cavity and gas handling system) is stabilized. This is typically the longest step in the startup sequence. The duration of this step can range from 5 to 60 minutes, depending on the ambient temperature and how much time has elapsed since the last startup.

2. *Entering Measurement*

Spectral scanning has started. Concentration measurements will be available in approximately 30 seconds. The instrument will continue

to scan and report concentration measurements until the instrument is shut down using the procedure below.

3. *Pressure Stabilizing/Locked*

The valve control system begins to allow flow through the analyzer and stabilizes the pressure inside the cavity.

4. *Measuring*

This is the normal mode of operation after startup has completed.

10. FILE MANAGEMENT

10.1 Overview

During operation, the Analyzer generates various ASCII-format text output files that are updated after each batch of concentration measurements is complete. For example, one of the user's output files is named *CKFBDS##-YYYY-MM-DD-hmm- DataLog_User_Sync.dat* where "CKFBDS##" or similar is the instrument serial number. The data files are created every 60 minutes.

The file name is generated from the instrument serial number, the date, and the time when the instrument was started. For example:

CKFBDS01-20070127-1029-DataLog_User.dat

CKFBDS01 is the instrument serial number

20070127 is the date, 1/27/2007, in format *YYYY-MM-DD* (to allow chronological sorting of data files).

1029 is the time the file was started, 10:29 am, formatted as *hhmm* using a 24-hour clock.

Raw Data

The raw user data is contained in folders in the directory: *C:\UserData\DataLog_User\year\month\day\hour*. This is data that has not been re-sampled to exact 0.1s time intervals. There is a similar directory (*C:\UserData\DataLog_Sync\..*) which includes data that is evenly spaced in time at the data rate of the analyzer.

File Deletion

File deletion frequency and details can be modified in the file:

C:\Picarro\G2000\AppConfig\Config\Archiver\Archiver.ini

Data Directories

During data acquisition, the analyzer creates directories to store the data, based on the date the data were acquired. After each data file has been closed it is moved to an archive directory, and a new file is started in the original location. The archive directory is *C:\Picarro\G2000\Log\Archive* and has subdirectories *DataLog_Mailbox*, *DataLog_Private* and *DataLog_EventLogs* with files arranged by *year\month\day\hour*.

There are complete data files which include additional information beyond the concentration data including parameters such as instrument temperatures and pressure, set points and spectroscopic information. This information is generally not useful to the user, but can be useful for diagnostic purposes and is stored in the following directory:

C:\Picarro\G2000\Log\Archive\DataLog_Private \[year]\[month]\[day]\[hour]

Current Data File

The current data file can be found in *C:\Picarro\G2000\Log\DataLogger*. Within this directory, there are subdirectories for *DataLog_Private*, *DataLog_User*, and *DataLog_User_Sync*. Similarly, the archive directory has subdirectories arranged by file type. The subdirectories are further organized by *\[year]\[month]\[day]\[hour]*.

To keep the data files easy to manage and to limit the size of individual files and directories, the software automatically generates new files each time the instrument is powered up and at midnight each night. When new files are created at midnight, their file name will contain the new date and a time of 00:00. For example, if the system was started at 10:29 am on 2/5/2007 it would create a file named:

20070205\CKFBDS01-20070205-1029-UserLog.dat

Then at midnight, a new file will be created:

CKFBDS01-20070206-0000-UserLog.dat

10.2 Data File Archival and Automatic Deletion of Old Files

The analyzer can automatically compress (zip) and archive old files. This operation is controlled by the initialization file:

C:\Picarro\G2000\AppConfig\Config\Archiver\Archiver.ini

For each file type, there are various items along with some recommended default settings which may vary by file type:

- **Directory = C:/UserData/DataLog_Sync**
Optionally specifies which directory to find files to the archive.
- **MaxCount = -1**
Specifies how many files to keep. A setting of -1 indicates that there is no maximum number of files. Generally, -1 is used in conjunction with a maximum size limit, below.

- **MaxSize_MB = 1500**
Specifies that a maximum of 1.5 GB of data is to be kept before the system begins to delete old data.
- **Compress = True/False**
Specifies if archived files are to be zipped – recommended setting is true to save hard drive space. True means files are zipped, false means files are not zipped.
- **AggregationCount = 0**
If compression is set to TRUE, specifies how many files to be included in each zip archive.
- **StorageMode = FIFO**
“First in first out.” Specifies that old data is deleted first.
- **Quantum = 4**
Generally, should not be changed. Specifies the files be sorted by year\month\day\hour in the archived directory structure.

In addition to the automatic file and directory management described above, the analyzer also automatically deletes various files specified in the initialization file:

C:\Picarro\G2000\AppConfig\Config\FileEraser\FileEraser.ini

This file contains the following settings:

- **runtime_interval_hrs = 0.5**
Specifies how often (in hours) to run the file eraser.
- **path = ../././Log/Archive/DataLog_Private**
Specifies which directory to look in for files to delete.
- **extension = data**
Specifies which files having what extension are to be deleted. If empty, it deletes all files.
- **delete_time_hrs = 48**
Specifies how long to keep files prior to deletion.

10.3 Setup Tool

In the desktop folder called Picarro Utilities, the Setup Tool can be launched by double-clicking on its icon. The tool allows the user to configure data file saving details, including which data elements are written to data files, digital data output (via serial port or TCP/IP), remote data delivery (via email), and general GUI properties.

Serial Communication

Picarro analyzers support an RS-232 physical command interface, which can be used to control the instrument and to retrieve concentration data. Not all features of the analyzer are available on the serial interface. For details on how to use the serial command interface, please see the *Picarro Analyzer Programming Guide* (included in pdf format on the installation CD). This command set may also be used across a TCP/IP interface through an Ethernet connection.

Configuring Data File Saving Details

The **Data Logger** tab allows the user to configure various data file saving details, including which data elements are written to data files.

- **Data Columns:** Controls which data elements are written to data files.
- **Hours of Each Log File:** Controls the size of each data document.
- **Enable Mailbox Archiving:** Enables archiving of data in the mailbox folder: `C:\Picarro\G2000\Log\Archive\DataLog_Mailbox`
- **Archived Directory Structure:** Specifies part of naming convention for data documents.
- **Total User Log Storage Size (GB):** Specifies the size of storage allowed for User Data (Recent Data).

After making the appropriate edits, click “Apply” to put changes into effect and then “Exit” to close the window.

Figure 21:
Data Logger
Setup Window

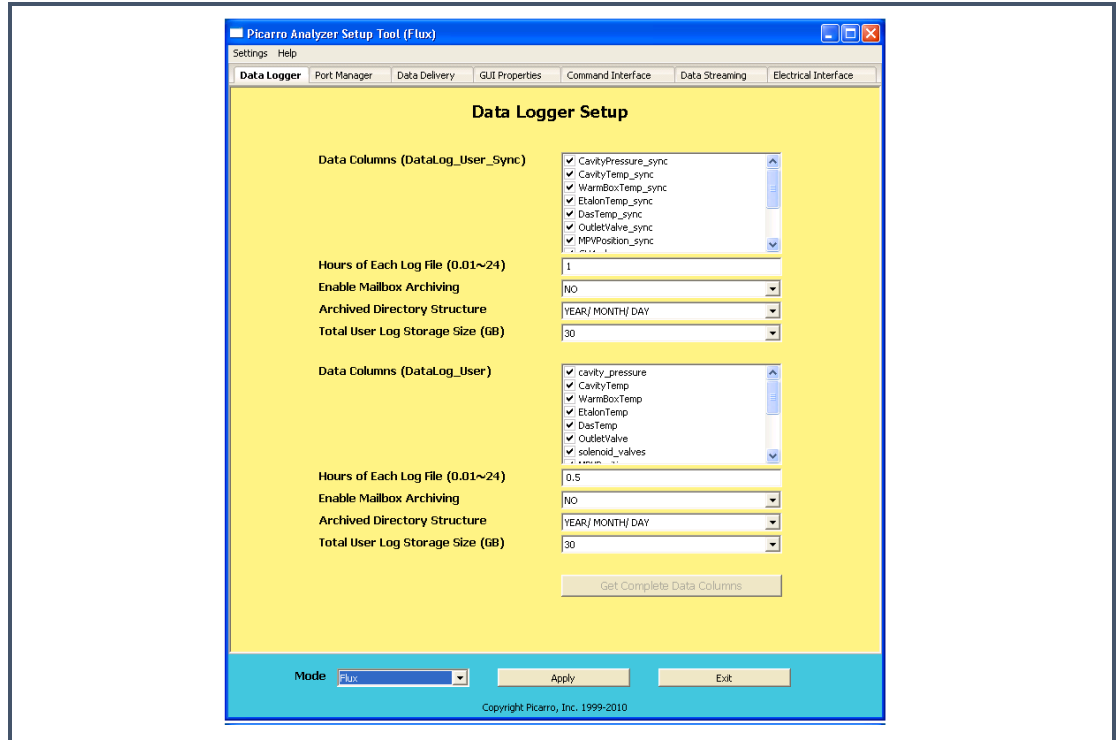

Serial/Socket Port Manager

The **Port Manager** tab allows you to control digital data output/Input via serial port or TCP/IP.

- **Data Streaming:** specify the port for data streaming (COM1/COM2/Off)
- **Valve Sequencer MPV:** specify the port for connecting to Valve Sequencer (COM1/COM2/Off)
- **Command Interface:** specify the port for Command Interface (COM1/COM2/ TCP/Off).

Make sure there are no COM port conflicts before clicking “Apply.” After making the appropriate edits, click “Apply” to put changes into effect and then “Exit” to close the window.

Figure 22:
Serial/Socket
Port Setup
Window

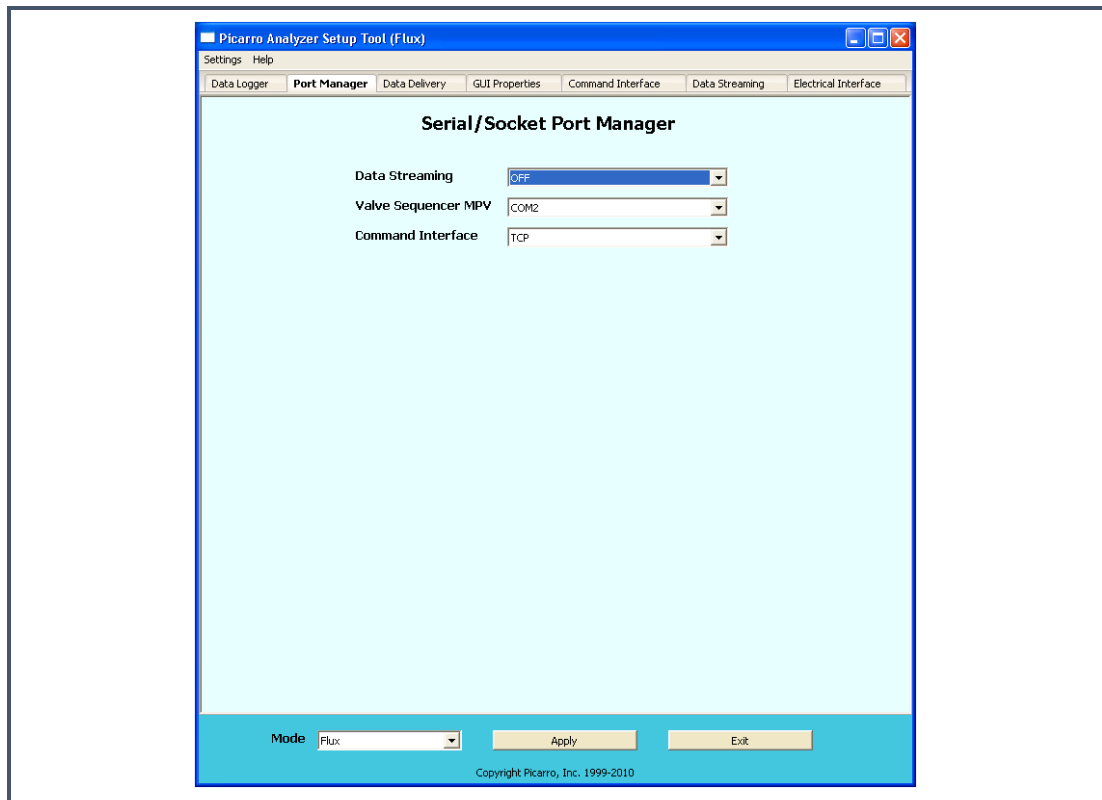

Data Delivery Setup

The **Data Delivery** tab allows the user to schedule remote data delivery via email.

- **Delivery Start Time:** Time of the day when data will be sent.
- **SSL:** Depending on the sender's email server, the sender can activate the Secure Sockets Layer (SSL).
- **Use Authentication:** Turning this on will require the receiver to provide a password and a username to access data. Set up the **password** and **Username** from this window.
- **From:** Sender's email
- **To:** Receiver's email.
- **Subject:** subject line of the email.
- **Data Directory:** Location of the data you want email.

After making the appropriate edits, click "Apply" to put changes into effect and then "Exit" to close the window.

Figure 23:
Data Delivery
Setup Window

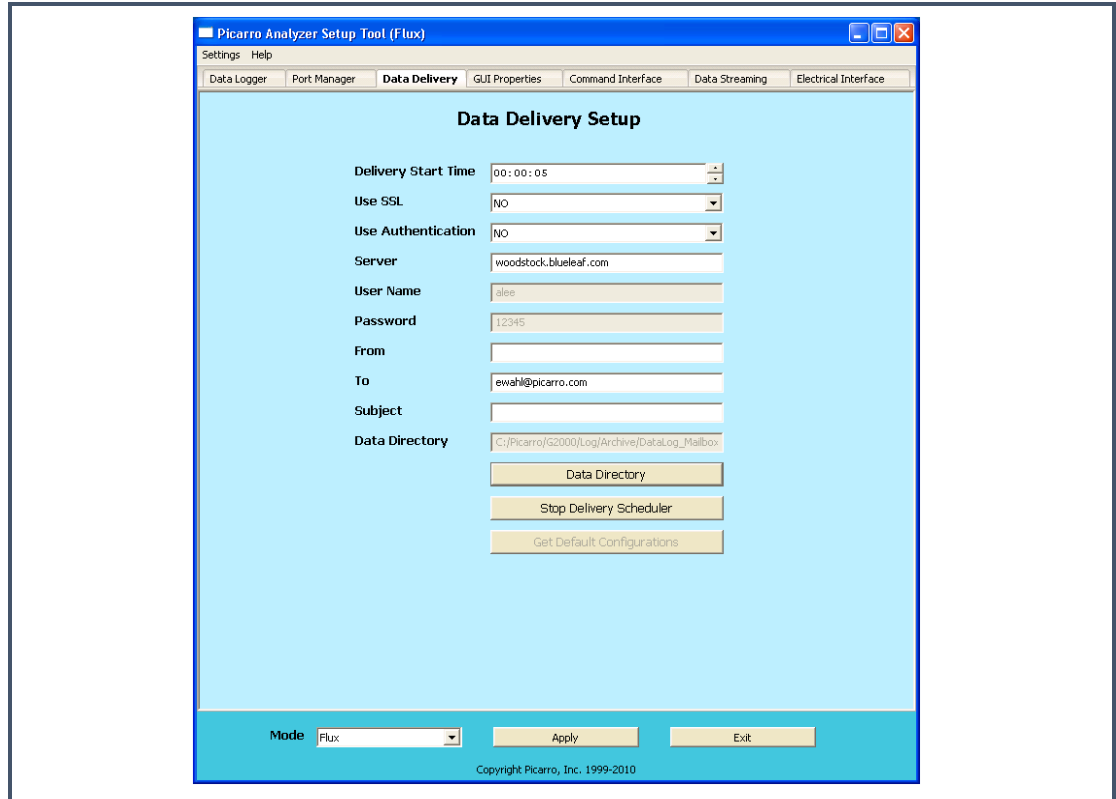

Editing Main GUI Properties

The **GUI Properties** tab allows you to set the number of line graphs visible on the main GUI.

In this tab, you can enable control of a connected Valve Sequencer from the main GUI:

1. Click on “Settings” of the “Setup Tool” window, and then “Switch to Service” mode.
2. Choose “Yes” next to “Enable Control Valve Sequencer” drop down menu on the “GUI Properties” tab.
3. Click “Apply” to put changes into effect and then “Exit” to close the window.

You should now be able to access the “Show/Hide Valve Sequencer GUI” menu from the main GUI under “Tools”

Figure 24:
GUI Properties
Window

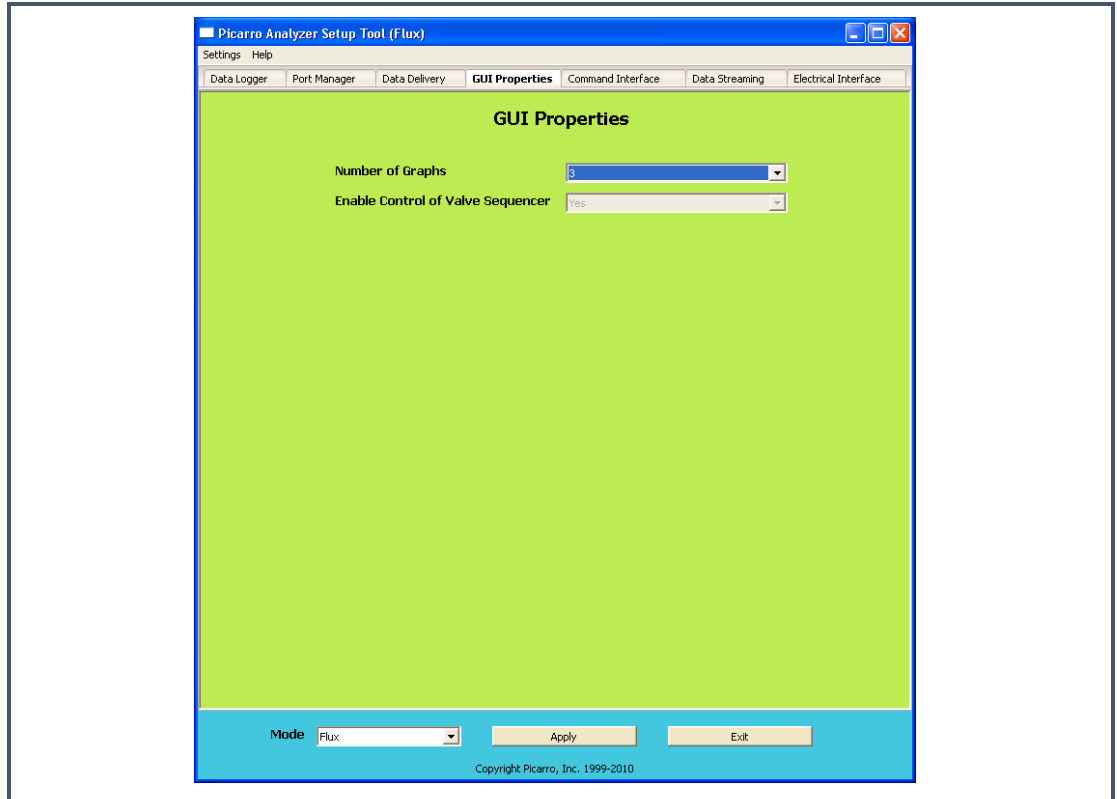

Specifying Digital Data Output for Command Interface

The **Command Interface** tab allows you to specify the data elements that are sent via COM port/TCP (specified in the Port Manager tab). Two types of data can be specified here: *Datalog_User* and *DataLog_User_Sync*.

After making the appropriate edits, click “Apply” to put changes into effect and then “Exit” to close the window.

Specifying Digital Data Output for Data Streaming

The **Data Streaming** tab allows you to specify the data elements that you want to send via COM port (specified in the Port Manager tab). Two types of data can be specified here: *Datalog_User* and *DataLog_User_Sync*.

Data Streaming outputs data continuously, whereas the Command Interface needs commands to prompt data output.

After making the appropriate edits, click “Apply” to put changes into effect and then “Exit” to close the window.

Figure 25:
Command
Interface
Window

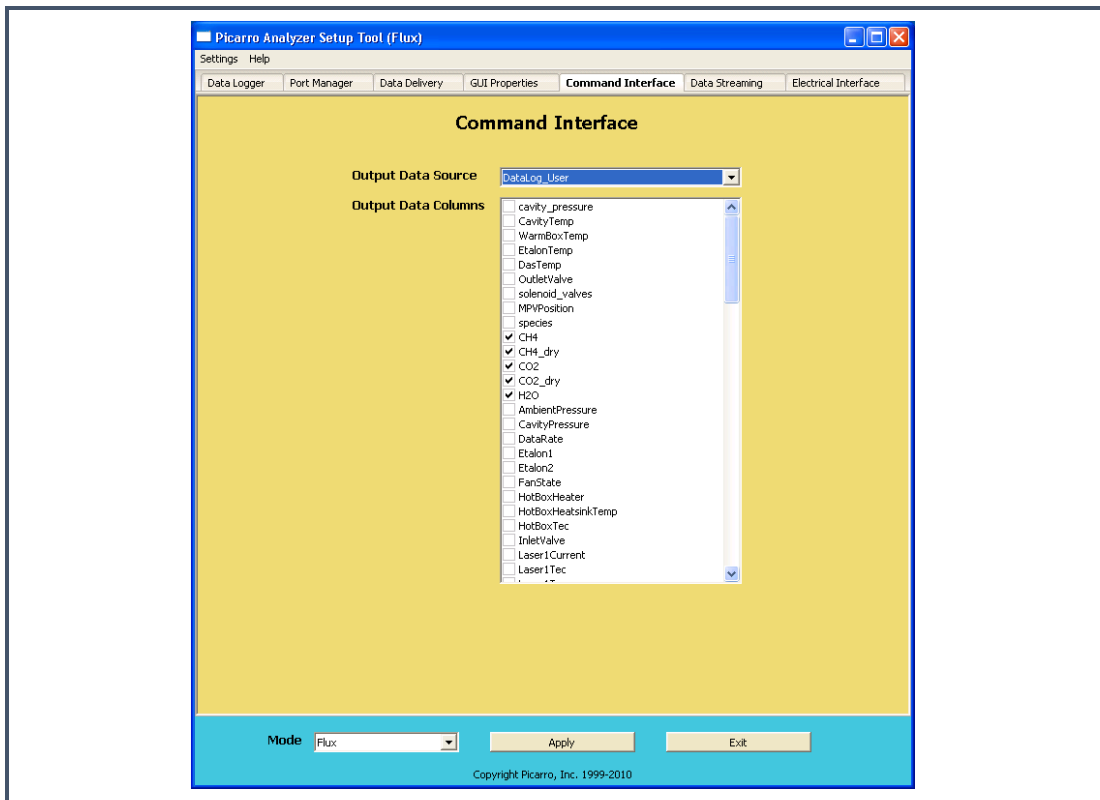
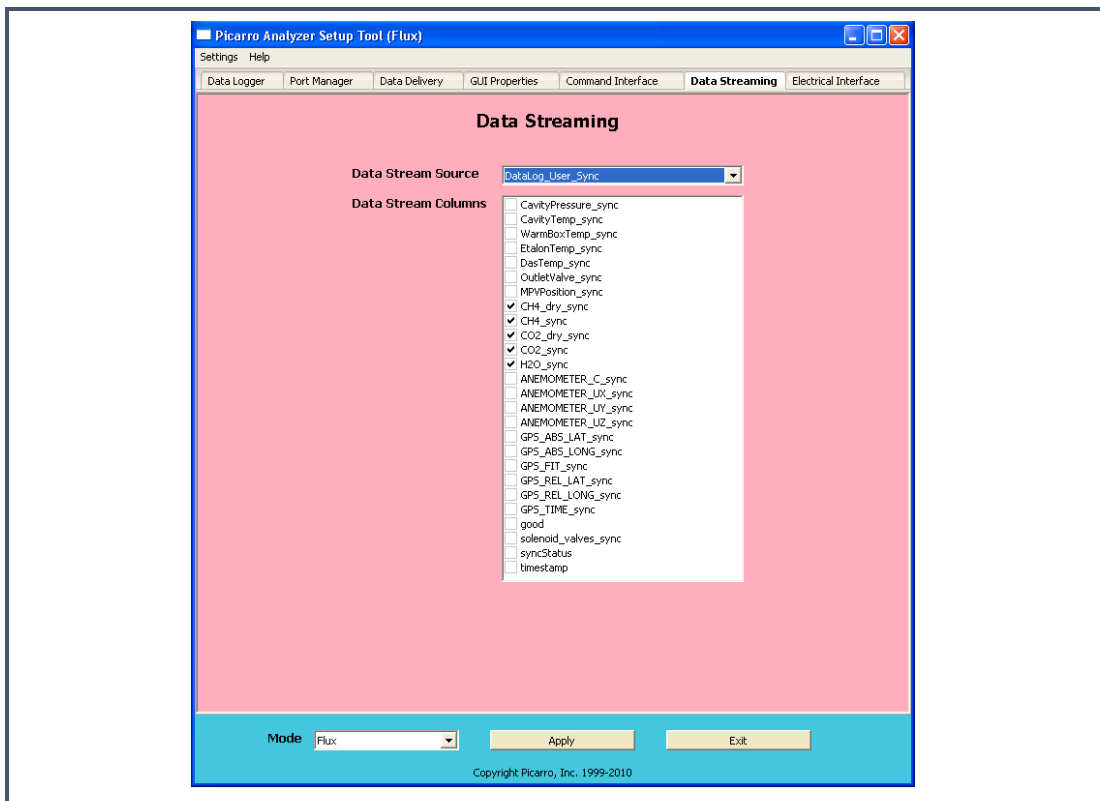

Figure 26:
Data
Streaming
Window



Customizing Analog Output Channels

The Picarro analyzer may be optionally configured with an Electrical Interface Card (EIC) that provides up to 8 analog signals available to the user for monitoring various measurements results and analyzer parameters.

The **Electrical Interface** tab allows you to customize each analog output channel. This tab will be disabled if your analyzer was not configured to work with an analog peripheral.

After making the appropriate edits, click “Apply” to put changes into effect and then “Exit” to close the window.

Figure 27:
Electrical
Interface
Window

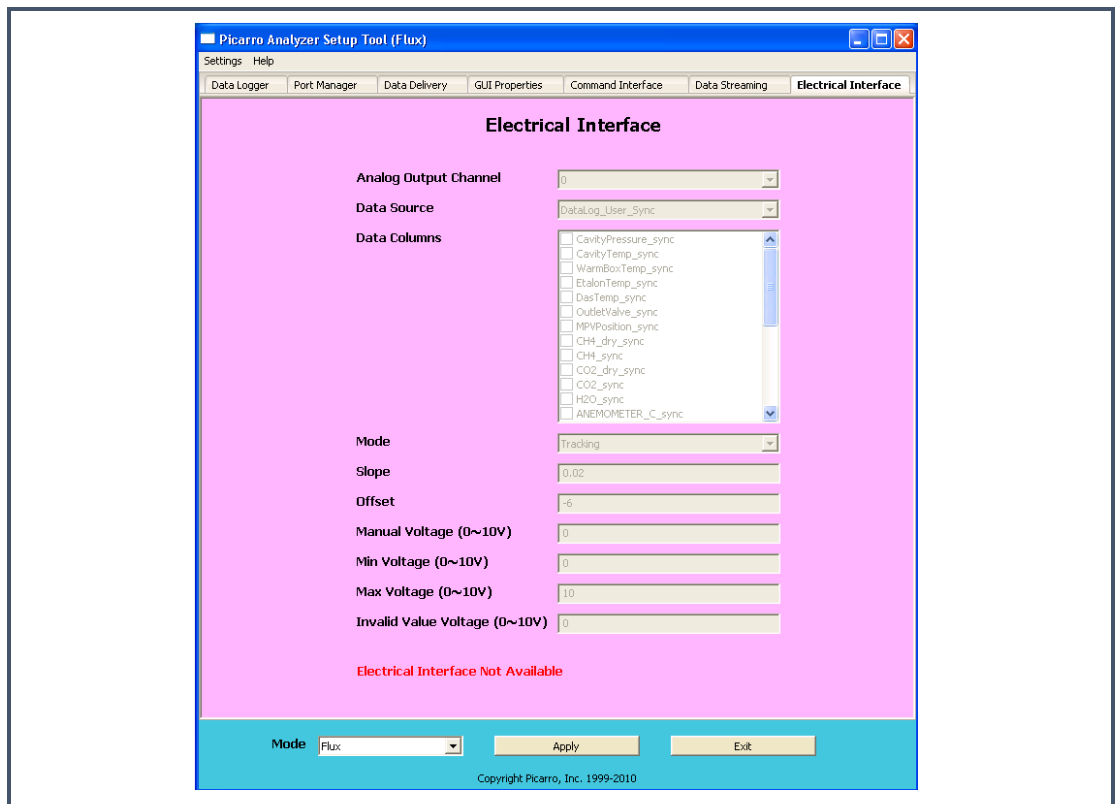

11. CALIBRATION

Periodic recalibration with standards of known concentration maintains the accuracy of these quantities. Using the Data Recal Software Utility (See *Calibration Software Utility Tools* on page 52) enables the calibration constants to be tracked over time, thus enabling the user to follow system performance.

11.1 Slope and Offset

Every Picarro analyzer ships with a default user calibration value of 1 for slope and 0 for offset. While new user calibrations will likely result in changes to both, we recommend that only offset changes are applied during more frequent calibrations.

If a new slope calibration is to be applied, the user must be mindful of their experimental uncertainty. For example, a change in the slope calibration from 1 to 0.95 may not represent a change in the system's linearity, but may simply reflect the experimental uncertainty. If during your slope calibration, a new value of 0.9 or 0.85 is suggested by the Data Recal tool, please repeat the measurements of your standards. In most cases, such large changes in slope are a result of uncertainty and do not indicate a bad nonlinearity of the analyzer. If your analyzer continues to suggest a large change in slope, please consult with Picarro Support before applying a new calibration.



NOTE

If you are uncertain about the state of your current slope and offset values, they can be reset back to their user default values of 1 and 0, respectively. In your Picarro GUI, navigate to “Tools -> User Calibration -> (password: picarro) ->” Then change the slope and offset values of your parameter of interest to 1 and 0, respectively.

11.2 Calibration Methodology

To perform a calibration or verification of calibration, the user introduces a calibration standard or surrogate gas into the analyzer for a period long enough for the analyzer to yield a stable measurement of that sample.



NOTE

If necessary, contact Picarro for further calibration guidance and reference materials. Please see page 3 for Contact Information.

Calibration Setup

This section describes the connections from the analyzer to the gas tank.

- The pressure regulator at the outlet of the gas tank protects the analyzer from over-pressurizing. The pressure should be set to about 1 - 3 psi.
- The toggle valve allows rapid shutoff of the gas delivery.
- Tubing is connected to the male quick-disconnect connector provided with the analyzer.
- The male connector is inserted into the inlet port of the analyzer.

To replace the gas tank:

1. Turn off the main valve on the gas tank.
2. Disconnect the pressure regulator assembly from the tank.
3. Connect the pressure regulator assembly to the next gas tank.

Measurement Time for Each Standard

The measurement period for a calibration standard is dependent upon the recorded precision of the standard gas and performance characteristics of the analyzer, using the Allan standard deviation plot.

Measuring Multiple Gas Standards

When measuring multiple gas standards, the order of the gas standard is not important. However, make sure that you measure the gas standard slightly longer than the time you determined in the previous section because the usable/effective data set will be trimmed down.

Calibration Data Processing

1. Process the calibration results from the .dat file (see *File Management* on page 39) and calculate the average recorded value for each standard.
2. Plot these values versus the certified values from the gas supplier, and determine the linear relationship between the known calibration values and the analyzer's reported values. A linear best-fit equation can be calculated from the data.



NOTE

It is important to plot the analyzer's reported concentration on the horizontal axis and the gas standards' stated concentrations on the vertical axis.

The slope and intercept of the best-fit line through these points are the two values that are used to calibrate the analyzer. By determining the linear relationship between the known calibration values and the analyzer's reported concentration values in this way, a calibration offset (slope and intercept) can be calculated to add a correction term to the analyzer's factory or previous calibration.

Entering the Calibration Setting

Changing the analyzer's calibration is intended to be done infrequently. Instead of recalibrating frequently to increase the accuracy of the data, users often just verify the calibration by measuring three or more gas standards and use the same regression procedure described here to calculate an offset by which to correct their data offline. Using the following equation in the graph below, this calculation would be accomplished point-by-point by calculating the corrected data "y" using the analyzer's data "x" so that:

$$\text{Data corrected} = 0.9866 \cdot \text{Dataraw} + 5.268$$

Figure 28:
Linear
Calibration
Example

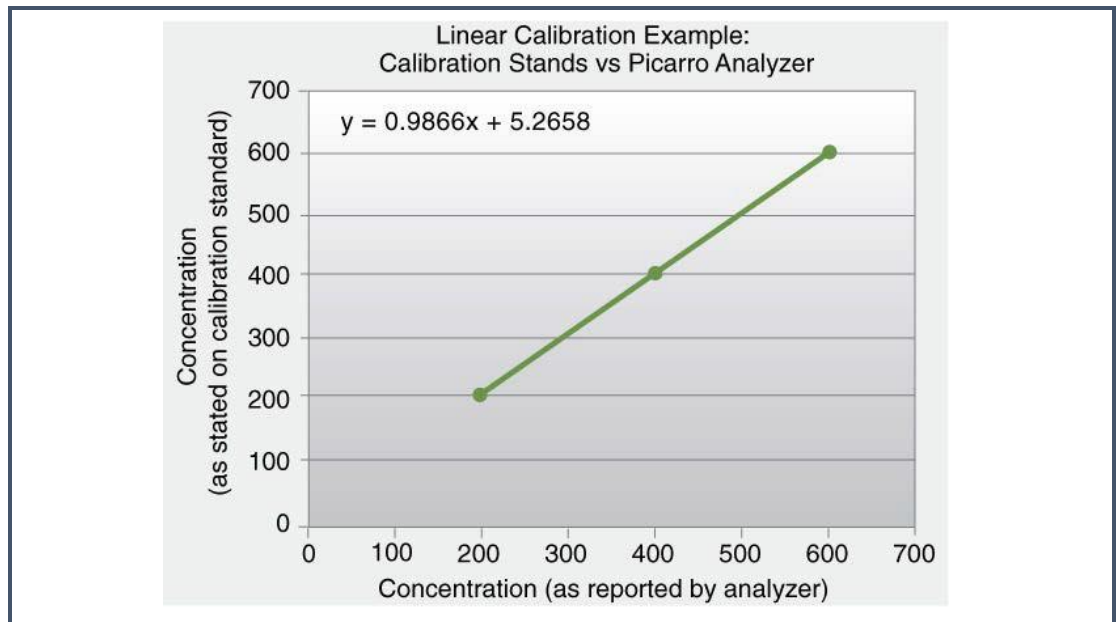

Calibration values are input into the analyzer by selecting **Tools > User Calibration**, and then entering the slope and intercept for each species.



NOTE

User Calibration is a password-protected form, and the default password is "picarro". This password can be reset in the *QuickGui.ini* file as previously described.

The calibration will take effect immediately after clicking **OK**. To return to the factory calibration, simply set the slope to 1 and the intercept to 0 for each species.

11.3 Calibration Software Utility Tools

Data Recal

The Data Recal software utility is designed to enable users to perform a routine concentrate calibration or calibration verification of Picarro's gas concentration Analyzer via a user-friendly interface.

Data Recal allows the input of ten calibration points. Some of these points can be used for recalibration, while the remaining points can be used as quality control calibrants. In an ideal situation, three concentration certified standards should be analyzed on the system to generate CRDS-reported values for concentration. The standards with isotopic values spanning and encompassing the intended sample analysis should then be used to build a standard calibration curve. Parameters of this curve will then be used to correct the instrument readings so that they match standard values. The other standards will be simultaneously used for quality control, to verify other recalibrated delta values against their certified delta values.

Data Recal GUI

The Picarro Data Recalibration ("Data Recal") software can be found in the "Picarro Utilities" folder on the desktop. The Data Recal software utility can be launched by double-clicking on the Data Recal Icon in the folder. Shown below is a screenshot of the window that will open.

Figure 29:
Data Recal
Software Utility
GUI

Used for Recal	Certified	CRDS Reported	Recalibrated
<input checked="" type="checkbox"/>	-35.6	-35.8	0.00000
<input checked="" type="checkbox"/>	8.6	7.6	0.00000
<input checked="" type="checkbox"/>	37.5	38.4	0.00000
<input type="checkbox"/>	13.6	13.2	0.00000
<input type="checkbox"/>	0.00000	0.00000	0.00000
<input type="checkbox"/>	0.00000	0.00000	0.00000
<input type="checkbox"/>	0.00000	0.00000	0.00000

	Current Calibration	New Calibration
Offset	1.87678	0.00000
Slope	0.54922	0.00000
R2		0.00000

Calibration Options: Offset + Slope

Buttons: Compute Apply New Cal Exit

Copyright Picarro, Inc. 1999-2009

The Delta Recal Software Utility comprises three sections:

1. Numerical input and selection:

Certified and **CRDS reported** values are entered in the white boxes. Standards that will be used for instrument recalibration are then selected by checking the corresponding box in the first column, labeled “Used for Recal.”

Figure 30:
Recalibration
section of Data
Recal Software
Utility GUI

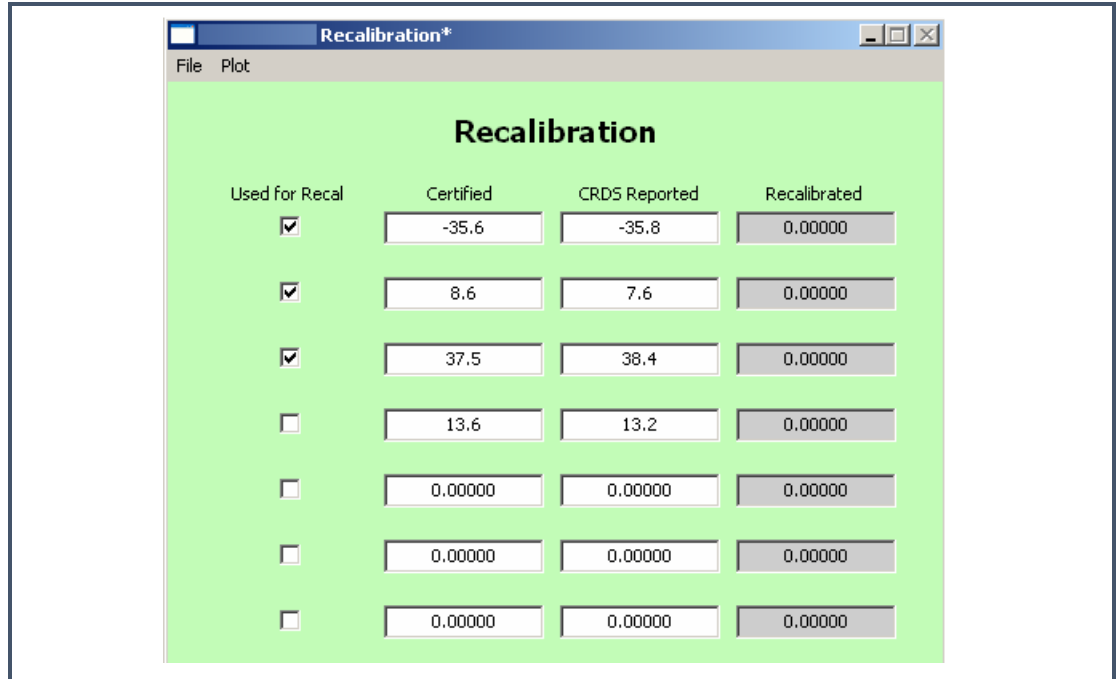

2. Calibration output:

In the “Calibration Options” drop-down menu, you can select either an “offset” or an “offset + slope.” Once the new calibration parameters are calculated, the Data GUI will display the new values under the “New Calibration” column. The parameters that appear here will depend on your initial selection. When the *Offset + Slope* option is selected, the program also calculates a goodness-of-fit correlation coefficient (R^2).

Figure 31:
Calibration
output section
of Data Recal
Software Utility
GUI

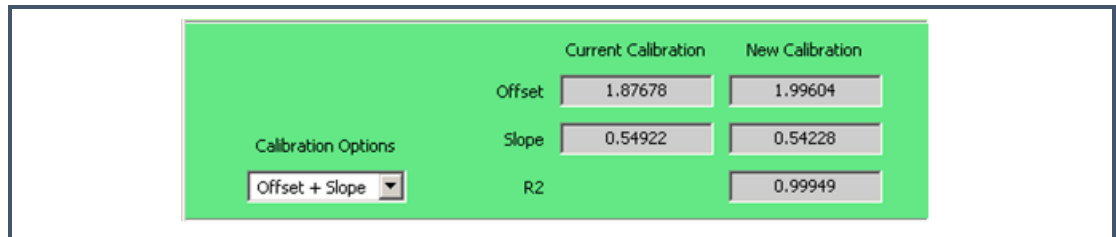

3. Action selection:

In this section, the user can click on the compute button to calculate the new calibration parameter(s). The compute button will be grayed out until values have been entered in the **Certified** and **CRDS reported** columns, and at least one pair of **Certified** and **CRDS reported** values selected for the calibration. Once these values are entered or selected, the “Compute” button will be active. Click “Compute” to calculate the new calibration parameters. These parameters will appear in the Calibration output section of the GUI,

and an asterisk “*” will be displayed at the end of the window title line, indicating the new change.

Figure 32:
Action selection section of the Data Recal Software Utility GUI

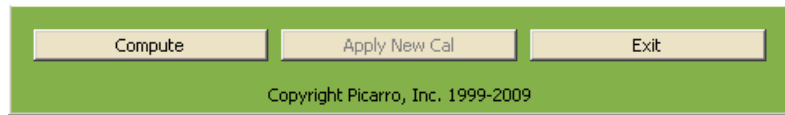

Once the calibration parameters are calculated, you can elect to graphically display the calibration and quality control (QC) standards in a graph. To do this, click “Plot” in the upper left corner of the window, and select “Plot Linear Fitting” from the drop-down menu, as shown below.

Figure 33:
Delta Recalibration



Figure 34:
Slope of Delta Recalibration

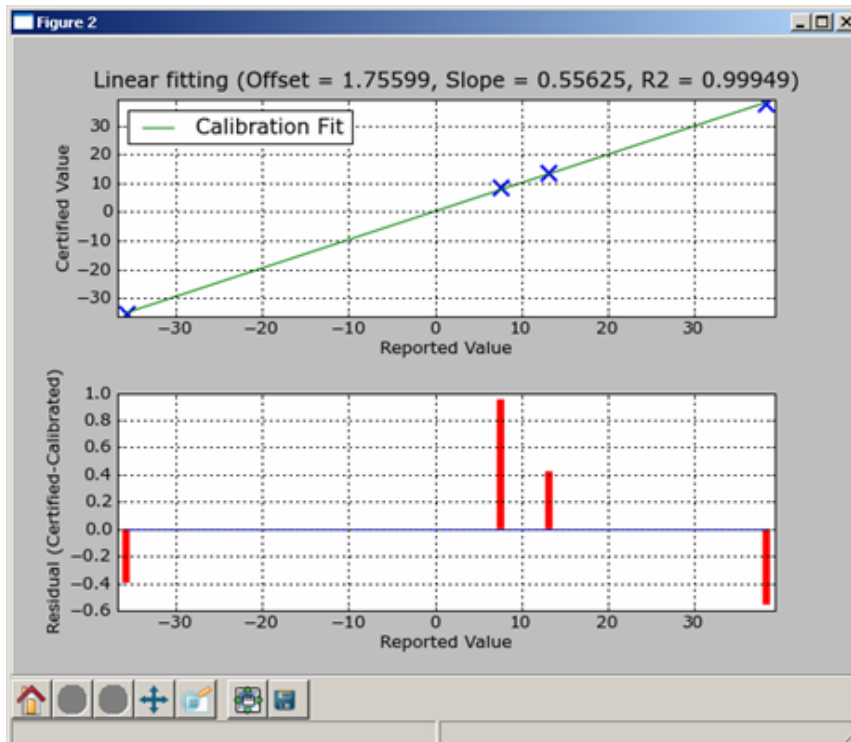

The plot that the utility will generate is shown below; this plot will display two graphs. The top graph presents measurements for the recalibrated standards (calibration and QC), as well as a line fit through those points.

The bottom graph shows the residuals, which shows how far each measurement is from the best-fit line.

If you decide to accept the new calibration values based on this plot, click on the “Apply New Cal” button.

Figure 35:
Apply new calibration slope and intercept

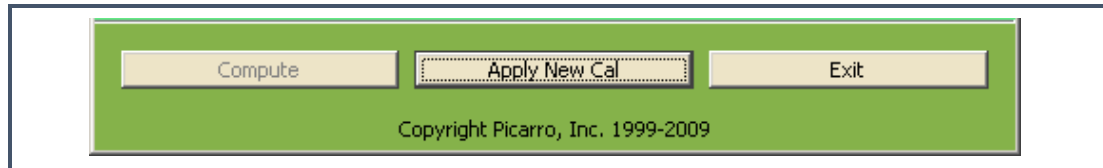

Then you will be prompted to enter a Calibration Password. **The default Calibration Password is “Picarro”.**

Figure 36:
User Authorization Dialog box

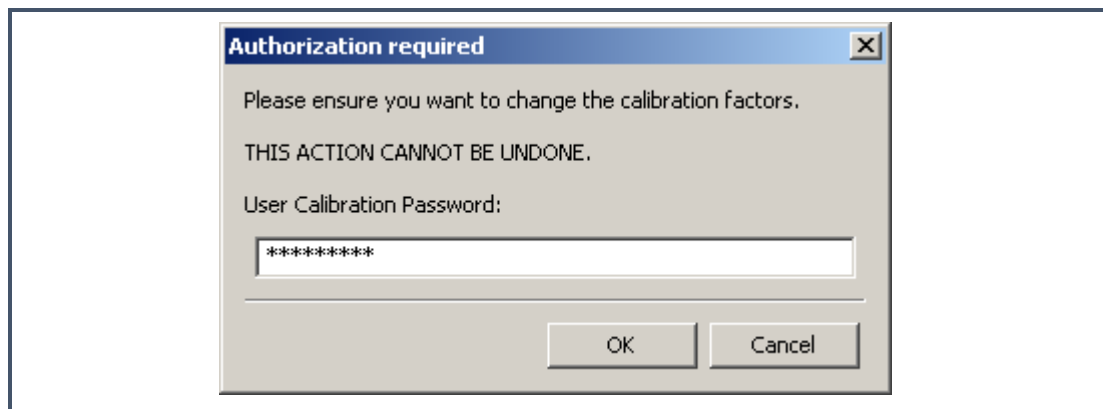

Next, a “Recalibration Confirmation” pop-up window will appear, displaying the new offset and slope (when applicable) values. This window will prompt you to confirm your choice to apply these values, to avoid any inadvertent mistakes.

Figure 37:
Calibration Confirmation Dialog box

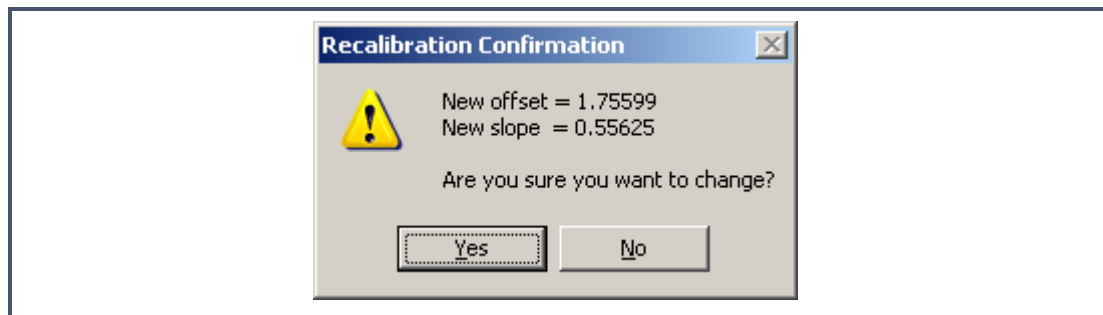

Please note that when you press the “Yes” button, the newly accepted calibration parameters will take effect immediately, without the need for the instrument main GUI to be restarted.

Once you accept the new calibration parameters, the Data Recal Software Utility automatically gives you the option to save the new recalibration file. Saving these files enables you to track the instrument recalibration history.

Saved files can be reloaded by clicking “File” in the upper left corner of the window, and selecting “Load Recalibration File.”

Figure 38:
Delta
Recalibration
Load File



Next, select the file that you want to load.

Figure 39:
File Browser
Delta Recal
File Option

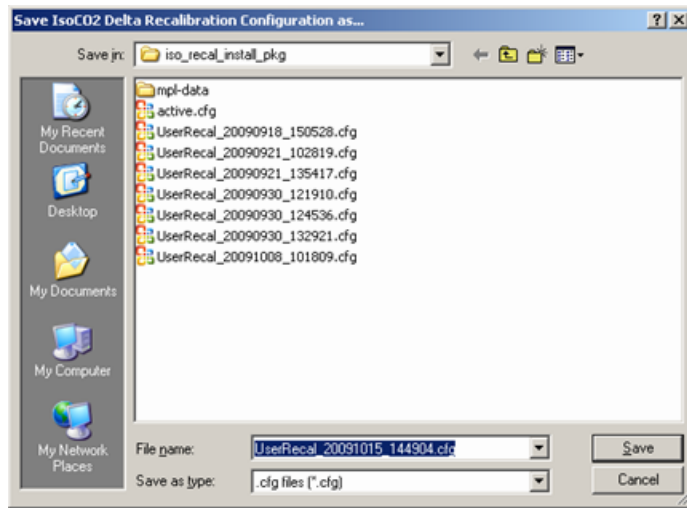

The recalibration file for this example will contain the following information:

Figure 40:
Delta Recal
Log File

	-35.6	-35.8	-35.20437
	8.6	7.6	7.64690
	37.5	38.4	38.05748
cc		1.75599	0.55625
nc		1.87678	0.54922
			0.99949
option		Offset + Slope	

Rows 1 – 3: values from each standard selected for recalibration. The first column in these rows lists the certified values, the second column lists the measured values, and the third column lists the recalibrated values. The number of rows will depend on the number of standards selected to be used for recalibration.

Current Calibration (cc) Row: read from left to right, list the current offset and current slope value.

New Calibration (nc) Row: read from left to right, lists the new offset and new slope values. The third value in this row is the R^2 value, which is only displayed if the calibration option is “offset + slope.”

Options Row: The last row displays the calibration option selected. If you choose to exit the Recal GUI before accepting the new recalibration values, you will be prompted to confirm your choice through a pop-up window. This window contains a warning that continuing to exit will cause the new calibration data to be lost.

Figure 41:
Recalibration
Exit
Confirmation

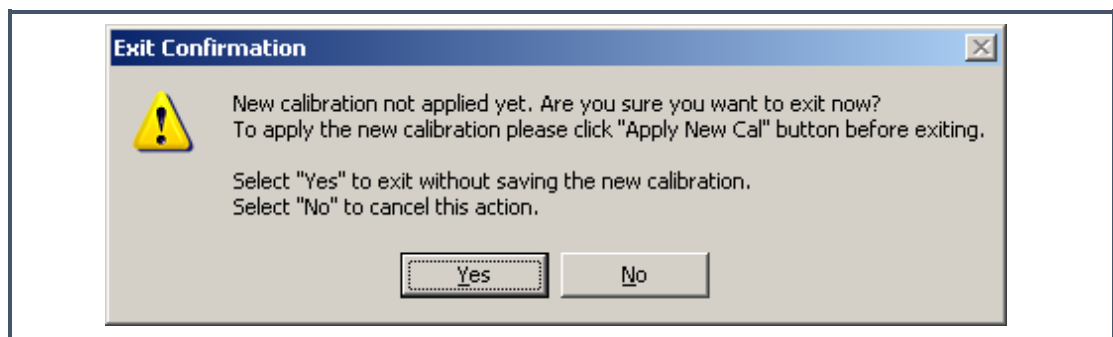

When you are finished with the calibration, you can exit the Delta Recal software utility by clicking on the “Exit” button at the bottom part of the Recal GUI.

Figure 42:
Calibration
Exit Button

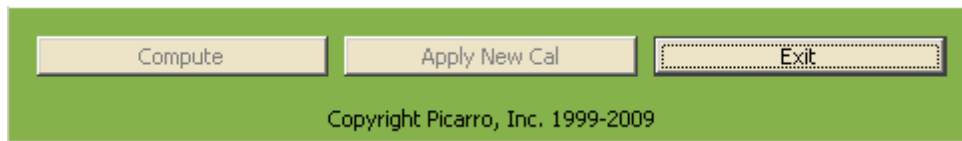

NOTE

The Recal GUI displays an error saying the new slope value is not acceptable when (1) at least two entries in either the Certified or CRDS reported columns contain zero-value numbers; (2) these entries are selected to be used for recalibration; (3) the “offset + slope” calibration option is selected. This error occurs because the entered values will lead to an erroneous zero-slope value.

Figure 43:
Invalid New
Slope Entry

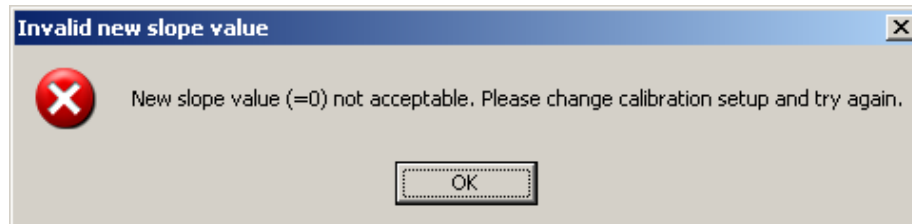

12.TROUBLESHOOTING

The following section lists problems that may be encountered during installation and operation of the analyzer. The corresponding step-by-step procedures provide resolution in most cases. If, after attempting these procedures, the problem remains unresolved, please contact Picarro Technical Support.

12.1 Power LED on analyzer does not illuminate

Context: Turning on the analyzer by momentarily depressing its front panel power switch should apply power. The green power LED is illuminated when it detects the correct power levels.

- a) Check that the AC power cord is attached and plugged into a working outlet.
- b) Check that the rear on-off switch near the AC power cord is in the on position.
- c) Press and hold the front panel power switch for at least 5 seconds as the analyzer may take several seconds to respond.

12.2 User Interface program does not start

Context: The computer may be configured to start the instrument and the associated user interface program automatically after it completes its boot-up sequence, or the program may be launched using the “Start instrument” icon on the desktop.

- a) Communications problems with the analyzer may occur if the analyzer fails to initialize correctly on power up. Should the analyzer initialization process not complete correctly, shut down the instrument by shutting down the Windows operating system on the control computer: use the Start menu, select the red Shutdown button and select “Shutdown” in the drop-down box under “What do you want the computer to do?”. Wait for the shutdown to complete normally and for the computer and analyzer to turn off completely. After a few seconds, restart the computer by momentarily depressing the power button.

Note: Do not simply restart Windows, since this does not cycle the power to the analyzer.

12.3 Sample pressure cannot be controlled to the appropriate value for concentration measurements

Context: Under normal operation, the cavity pressure is automatically locked to the correct value by means of electronically controlled inlet and outlet valves. The message “Pressure Locked” on the front panel display and the user interface indicates that the cavity pressure is at the appropriate value. Should either of the messages “Pressure high” or “Pressure low” be displayed, the cavity pressure is out of its correct operating range.

- a) The “Pressure low” message indicates that there is insufficient gas available at the inlet of the analyzer. Check the inlet plumbing to the analyzer and ensure that the pressure at the inlet is within the specifications.
- b) The “Pressure high” message indicates that gas cannot be removed from the analyzer at a sufficient rate. Check the vacuum line between the analyzer and the power vacuum unit for leaks. Failure of the vacuum pump, injecting dilution gas at excessive pressure, or excessive pressure at the inlet can also cause this problem.

12.4 User interface program “freezes” and does not update graphs as data are collected.

Context: The computer may become unresponsive causing the programs that control the analyzer to stop functioning. The computer and analyzer should be shut down and restarted.

- a) Resetting the computer and the instrument requires that the computer is shut down and restarted. If the computer responds to the mouse, a normal Windows shutdown may be carried out: use the Start menu, select the red Shutdown button and select “Shutdown” in the drop-down box under “What do you want the computer to do?” Wait for the shutdown to complete normally and for the computer and analyzer to turn off completely. After a few seconds, restart the computer by momentarily depressing the power button.
- b) Do not turn off the vacuum pump.
- c) If the computer does not respond to the mouse, hold down the power switch on the front panel for a few seconds until the computer and the instrument turn off. After another few seconds, restart the analyzer by momentarily depressing the power button.

13.SERVICE AND MAINTENANCE

13.1 Consumables and Replacement Parts

The following parts can be ordered directly from Picarro as needed over the lifetime of the analyzer. For contact information please see page 3.

Part Number	Description	Expected Servicing Frequency
S1020	Particulate filter kit for input sample line	After 12 months
C0360	Desiccant Drier Kit	After 12 months
S2009	Rebuild kit for A2000 Pump	After 15,000 hours
S2068	Complete fan replacement kit	After 2-3 years
A2000	External vacuum pump	After 40,000 hours

13.2 Particulate Filter Replacement

There are two inline, sub-micron particulate filters before the measurement cavity. The first is user-replaceable and replacement filters can be purchased from Picarro and installed by the user. It is important to NEVER remove the filter that is directly attached to the cavity. Only change the filter immediately following the inlet at the back of the analyzer. Refer to the filter replacement procedure in this document for further details.

The symptoms of a clogged filter can be analyzed reporting “pressure low” or there being no flow into the instrument, causing unusual measurements. Filters can become clogged after years of use in dirty environments.

If liquid water is accidentally sucked into the inlet line, it will clog the filter and impede the flow (usually for a few days) until it evaporates. If this occurs, it is important to NOT turn off the analyzer or replace the filter until it is dry. The reason for this is that the increased humidity due to liquid water in the filter can cause condensation on the optics if the analyzer is allowed to cool from its operating temperature. Often, after the filter dries, the analyzer will begin functioning normally, and a filter replacement is not necessary.

Tools Required

- 1.5mm Hex driver
- 9/16" open-end wrench
- 5/8" open-end wrench
- 11/16" open-end wrench

Removing the Old Particulate Filter

1. Move the analyzer to a clean work environment.
2. Using a 2 mm hex driver, remove the top lid of the analyzer by removing six M3 x 6mm socket flathead screws.
3. Loosen and remove the 2 screws on the inner long side of the bigger box. Open the lid (see below).

Figure 44:
Remove 2 screws and open the lid of the bigger inner box within the analyzer.

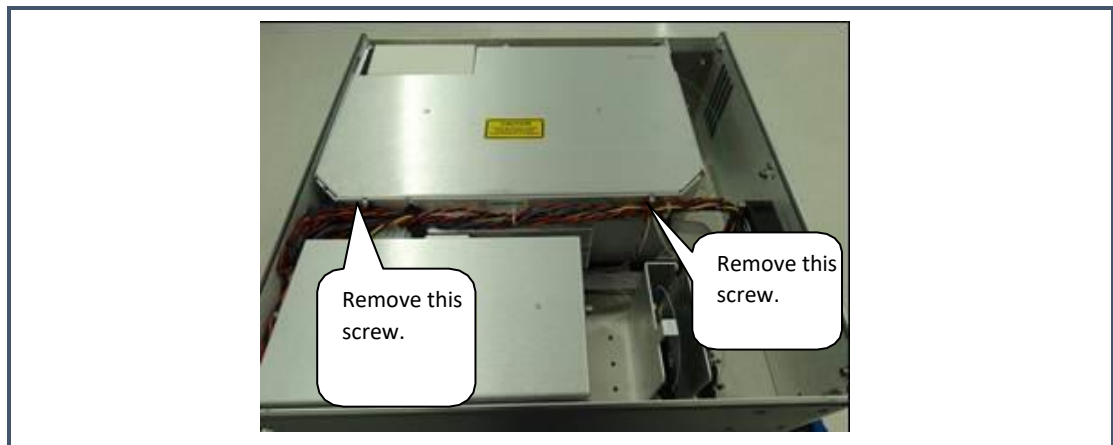

4. Using a 5/8" wrench, loosen the retaining nut on the input bulkhead (about 1 full turn should be enough).
5. Slide the foam towards the left side of the analyzer (from the back of the analyzer) to remove it (see below).

Figure 45:
Remove the
foam cover.

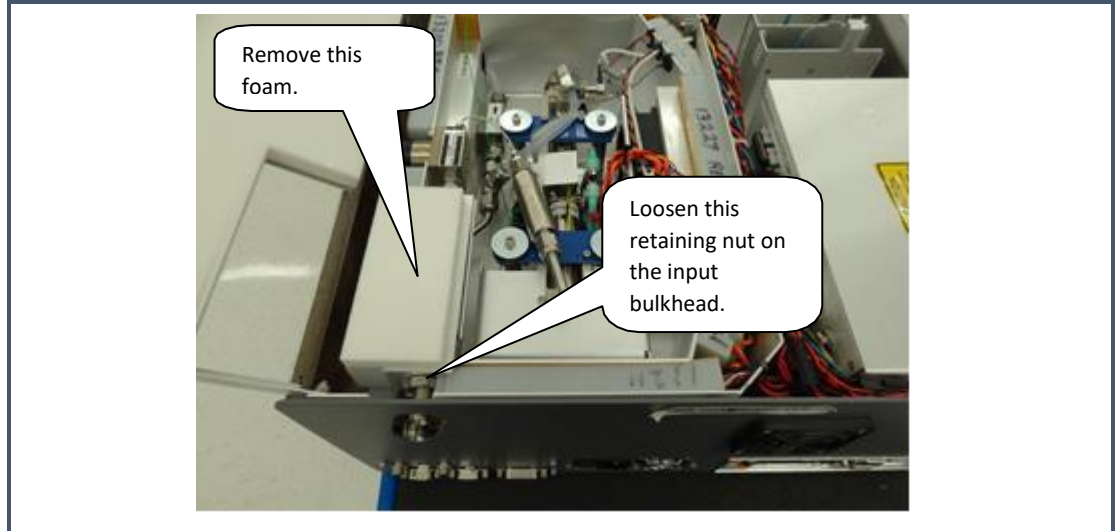

6. Using the 9/16" and 11/16" wrenches, loosen two nuts that are connecting the filter to the analyzer.

Figure 46:
Nut Removal
Process:
Loosen the
Fitting Nut first.

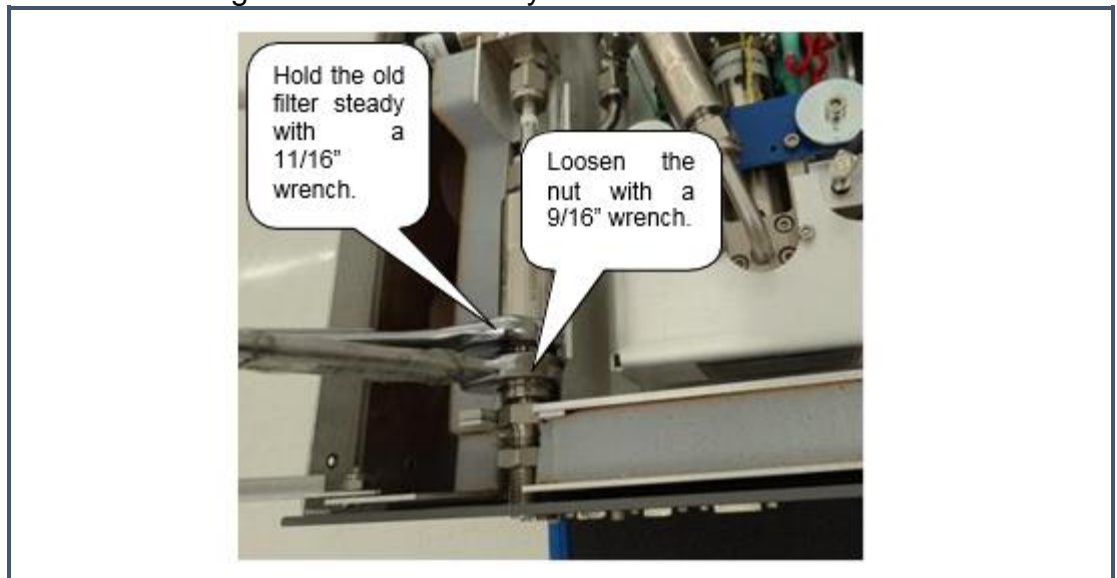

Figure 47:
Loosen Input
and Output
Filter Nuts

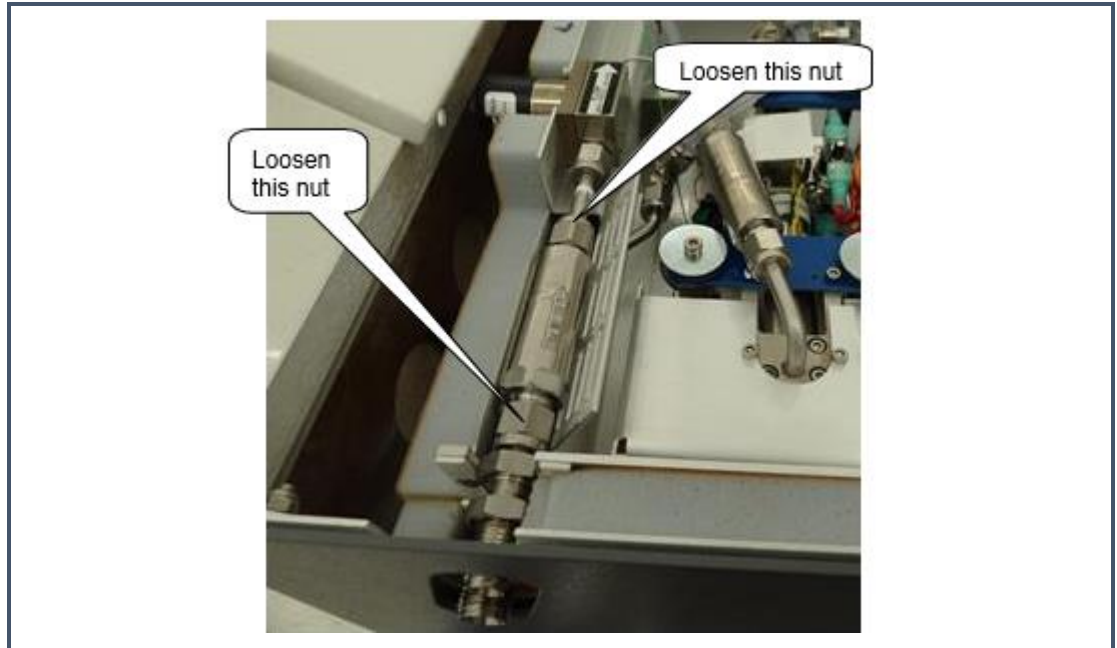
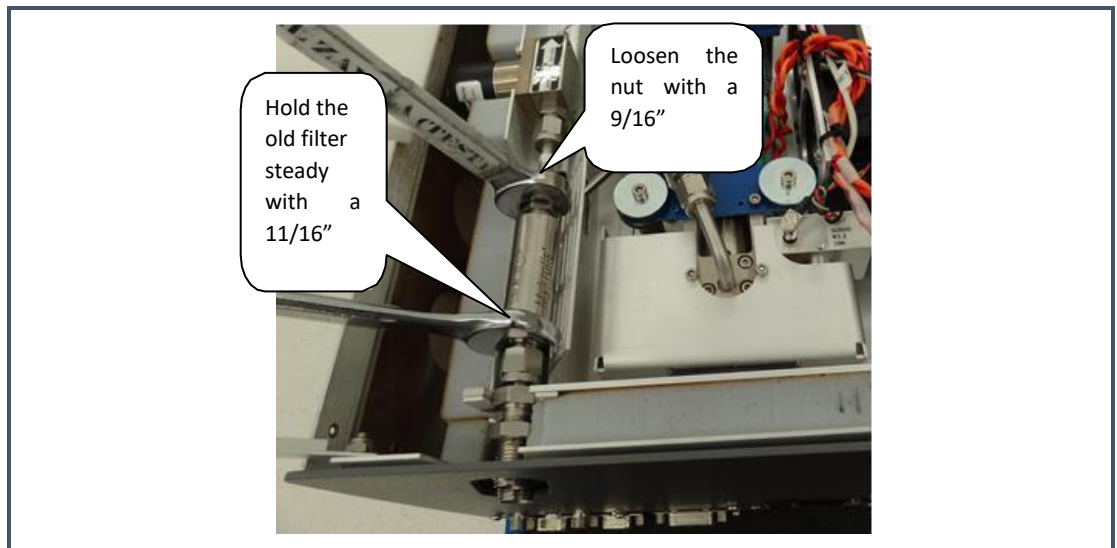
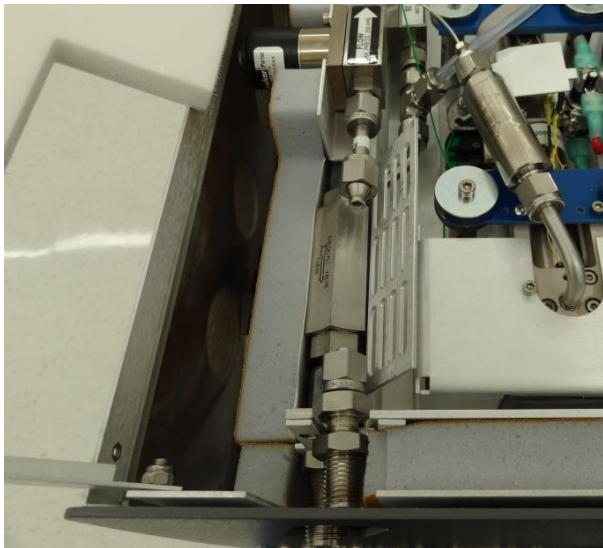

Figure 48:
Loosen Output
Filter Nut



7. Slide the filter slightly towards the back of the analyzer and lift it out.

Figure 49:
Slide the old filter back and out to remove.



Installing the New Filter



NOTE

When re-attaching 1/4" Swagelok fittings, the nut should be hand-tightened and then turned an additional 1/8 of a turn using a wrench.

1. Remove the filter from its packaging.
2. Using the 9/16" and 11/16" wrenches, attach it to the two nuts. The arrow on the filter needs to point away from the back of the analyzer.

Figure 50:
Insert the new filter making sure the arrow is pointing toward the Output Nut.

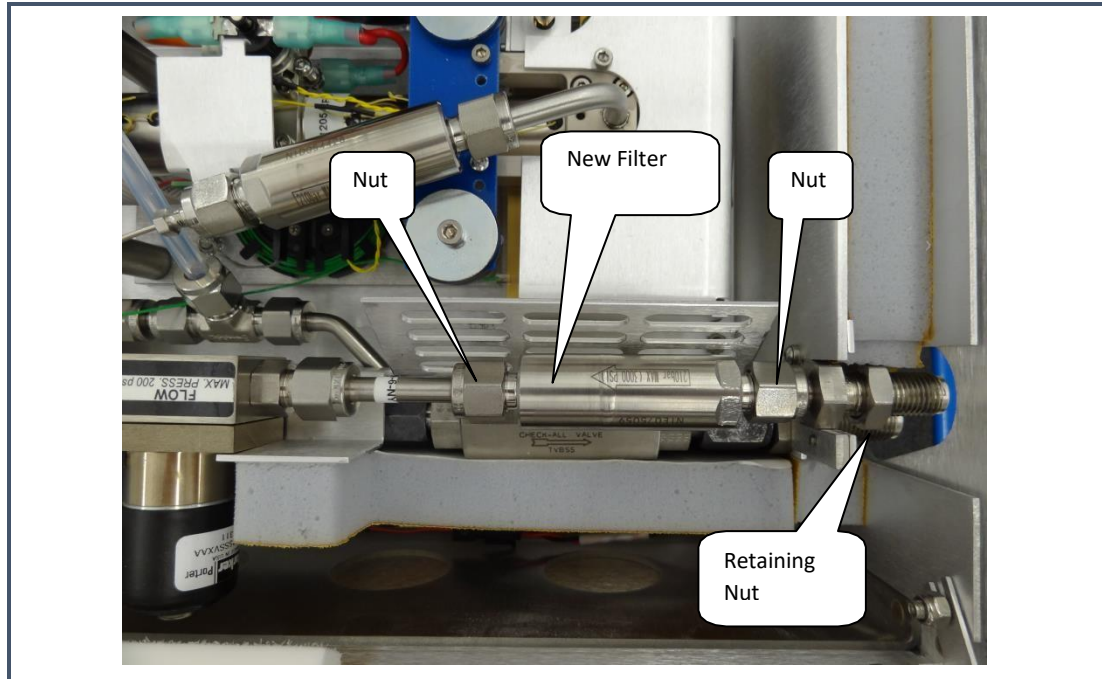

3. Using a 5/8" wrench, reposition the filter foam cover and tighten the retaining nut on the bulkhead fitting. The metal edge of the filter cover should be under the foam.
4. With a 2 mm hex driver, reattach the analyzer's top with 6 screws.

13.3 Case Fan Assembly Replacement

Items/Tools Required:

- 2 mm Hex driver
- 1/4" open end wrench

Procedure:

1. Completely power down the instrument
2. There are total of four case top fan Assembly 60 mm and 40 mm respectively on the top and bottom of the instrument.

Figure 51:
Case Fan
Power
Connection



3. Flip the analyzer so that it rests upside Down and the bottom layer is accessible open the bottom cover using 2 mm hex drive.
4. Locate the PCBA. Safely remove the power connectors out from the PCBA.
5. Locate the 40 mm fan assembly. Use 1/4" wrench to remove all the four screws and replace with the new fan.

Figure 52:
Case Fan
Assembly



6. Same procedure should be followed to replace the top side fan assembly. After disconnecting the power connectors on the back panel PCBA, flip it over to remove the front cover.
7. Locate the 60 mm fan assembly and replace with the new fan assembly.

13.4 CPU Fan Replacement

Items/Tools Required:

- mm Hex driver
- Phillips Screwdriver

Procedure:

1. Completely shut down the instrument.
2. Flip the analyzer so that it rests upside-down and the bottom layer is accessible.
3. Open the bottom cover.
4. Locate the Mother Board. Locate the CPU fan, unscrew all four corner screws and Replace with the new fan.

Figure 53:
CPU Fan



13.5 Replacing Vacuum Diaphragms and Valves



Never operate the pump if covers or other parts of the pump are disassembled. Never operate a defective or damaged pump. Check every motor capacitor regularly by measuring its capacity and estimating its service life. See A2000 Pump Manual for more information and servicing instructions.

Overview

The valves and diaphragms as well as the motor capacitors are wear parts. If the rated ultimate vacuum is no longer achieved or in case of increased

noise level, the pump interior, the diaphragms and the valves must be cleaned and checked for cracks or other damage.

All bearings are encapsulated and are filled with long-life lubricant. Under normal operating conditions, the drive system is maintenance free. In demanding circumstances, it may be efficient to check and clean the pump heads on a regular basis. In normal use, the lifetime of the diaphragms and valves is typically 15,000 operating hours.



CAUTION

Prevent internal condensation, transfer of liquids or dust. The diaphragms and valves will be damaged if liquid is pumped in significant amount. Carry out maintenance frequently if the pump is exposed to corrosive media or in case of deposits.



CAUTION

Service only one side of the pump at a time to avoid the mixing of parts.

Required Tools

A Pump Rebuild Kit (part number S2009) can be ordered directly from Picarro and includes 4 diaphragms, 8 valves, a 46 mm diaphragm key, and a silicone rubber tube for the pump's silencer.

In addition to the above, you will also need the following tools:

- 15 mm open-end wrench
- 4 mm Allen key
- Phillips screwdriver size 2

Safety Requirements

Follow the safety precautions as described in Section 5, "Safety."

Checking Diaphragms and Valves

Before starting the procedure, familiarize yourself with the different parts involved as outlined below:

Figure 54:
Diagram of the
diaphragms and
valves in A2000

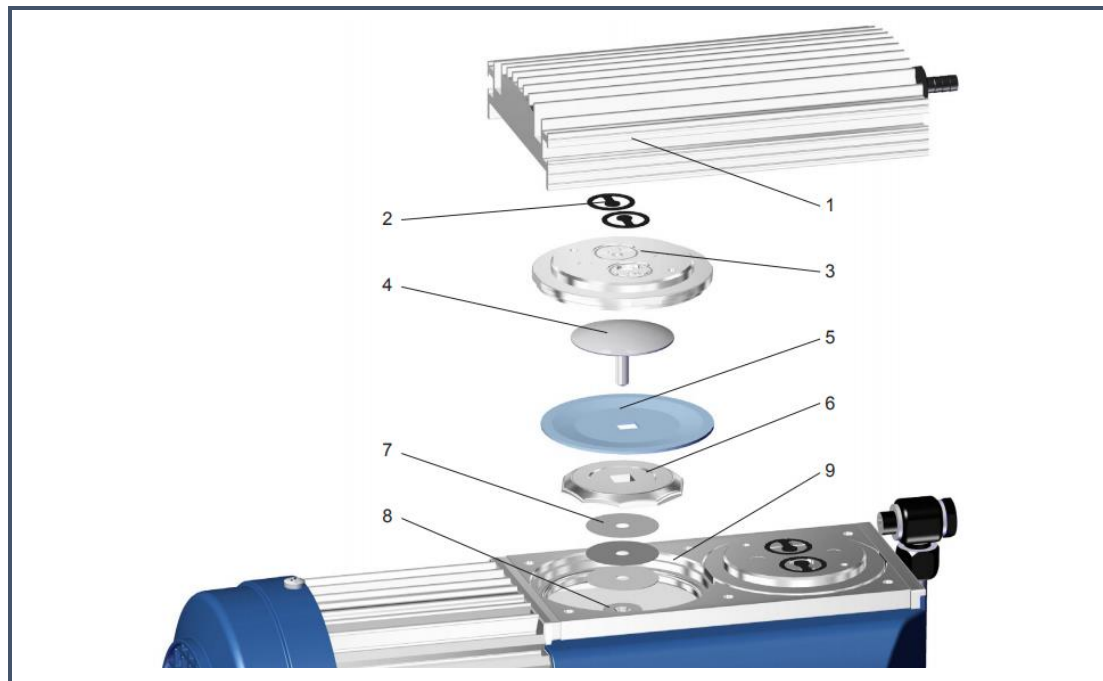

Position	Component
1	Housing cover
2	Valves
3	Head cover
4	Diaphragm clamping disc with square head screw
5	Diaphragm
6	Diaphragm support disc
7	Washers
8	Connecting rod
9	Housing

1. Use the 15 mm open end wrench to loosen the nut holding on the housing cover.

Figure 55:
Loosen the nut
securing the
housing cover



2. With the Phillips screwdriver, remove the two screws at the base of the pump handle and then carefully dislodge and remove the handle.

Figure 56:
Removing
the handle

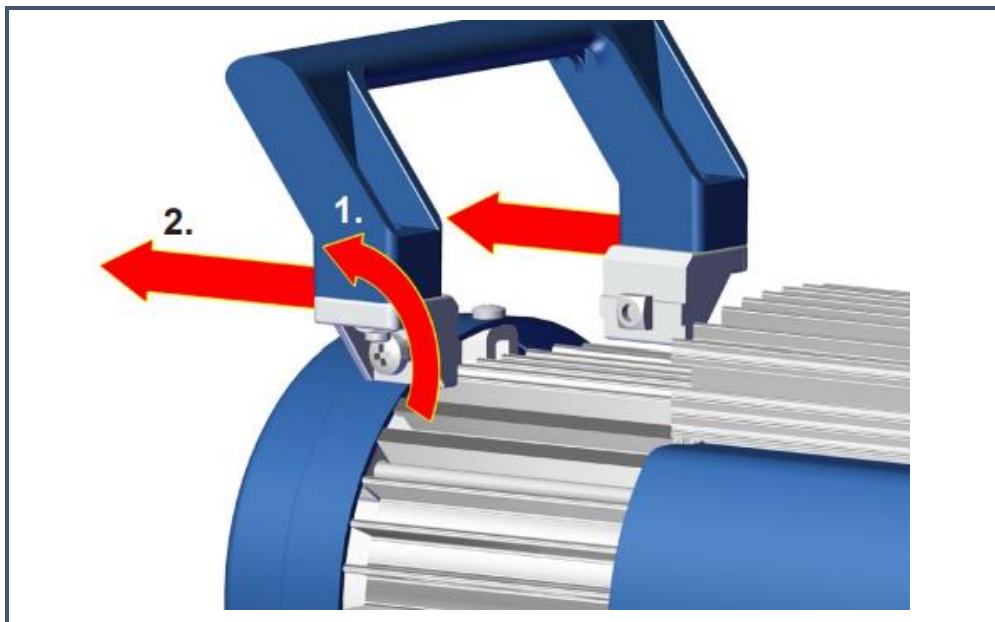

3. Using the 4 mm Allen key, loosen and remove the 6 screws in the housing cover.
4. Remove the housing cover and set aside.

Figure 57:
Remove the housing screws and then the housing cover

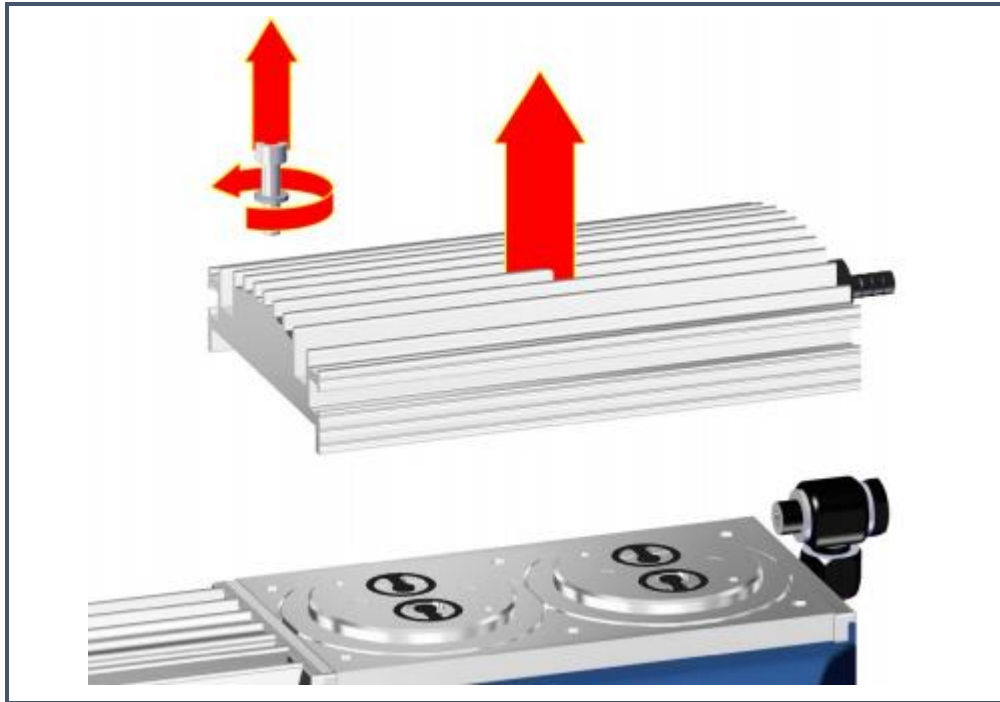

5. Remove the head cover and valves you would like to inspect. It is recommended to only service one side at a time.

Figure 58:
Visually inspect the valves

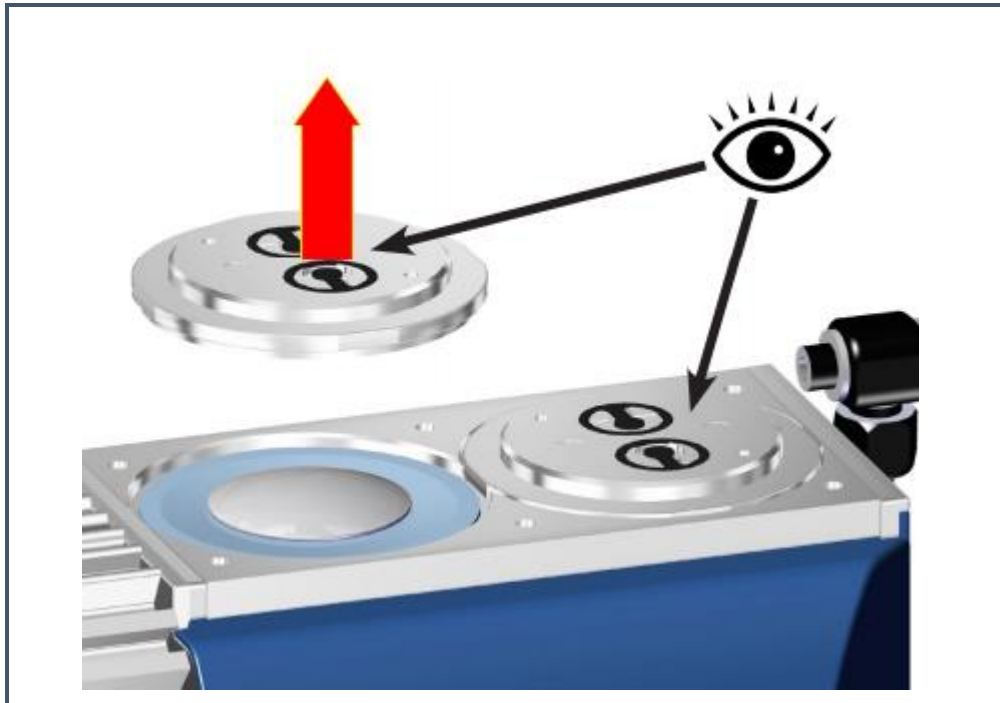
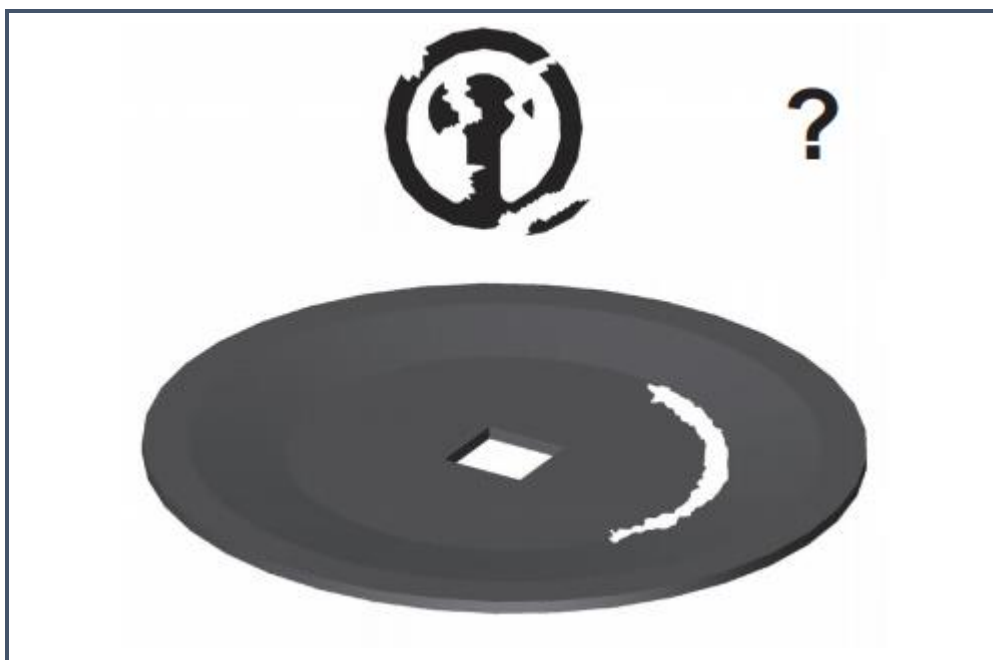

Figure 59:
Removing the
valves from the
head cover



- Carefully remove the valves and clean if necessary. Do not use sharp instruments to remove the valves. If the valves appear worn or show damage, replace with new valves provided in the S2009 Pump Rebuild Kit.

Figure 60:
Signs of
damage to the
valves and
diaphragm



Replacing the Diaphragm

1. Carefully fold in the edges of the diaphragm to reveal the diaphragm support disc below. Do not use any sharp tools as this can damage the diaphragm.

Figure 61:
Lift the edges of
the diaphragm

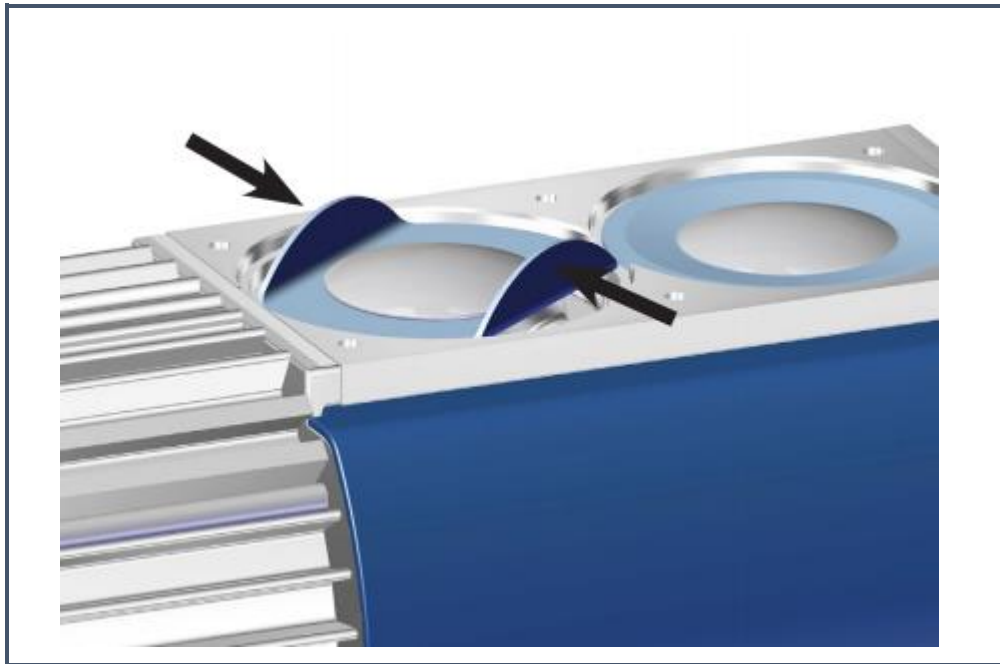

2. Align the 46 mm diaphragm key with the edges of the diaphragm support disc.

Figure 62:
Align the
diaphragm key

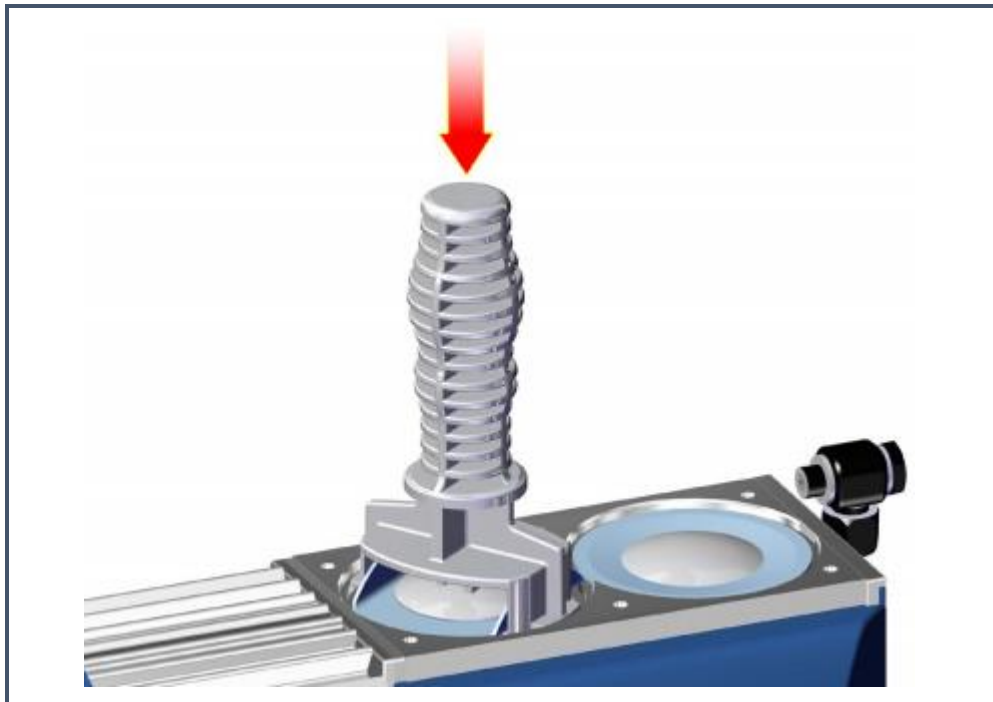

3. Apply pressure on the diaphragm key and turn counter clockwise to release the diaphragm clamping disc. As you remove the components be sure to note the order they are removed in and the number of washers.

Figure 63:
Order of
components
beneath the
diaphragm
clamping disc

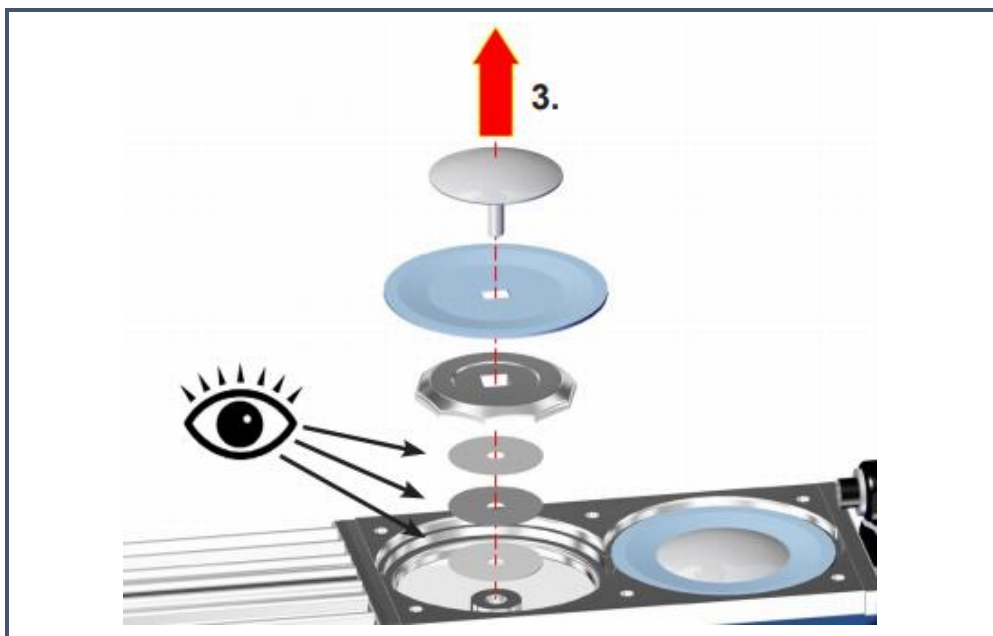

4. Replace the old diaphragm making sure to place it with the blue side of the diaphragm facing the diaphragm clamping disc.

Figure 64:
Correct
diaphragm
orientation

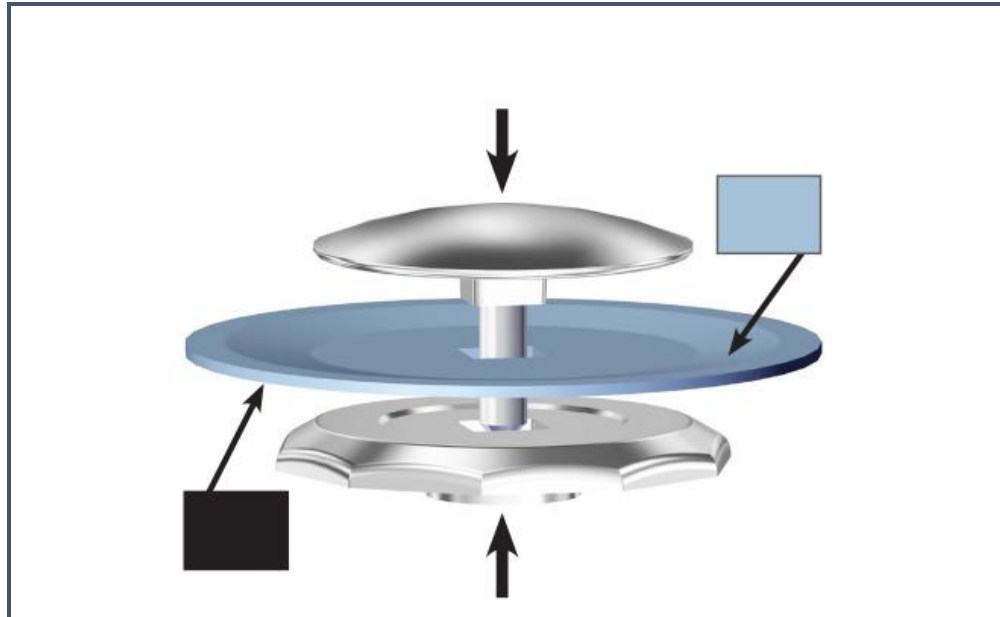

5. Align the square head of the diaphragm clamping disc with the opening on the diaphragm support disc and make sure it is properly seated.
6. Replace any washers as necessary.
7. Using the diaphragm key, locate the connecting rod and reset the diaphragm clamping disc, diaphragm, and diaphragm support disc.

Figure 65:
Confirm the
number of
washers

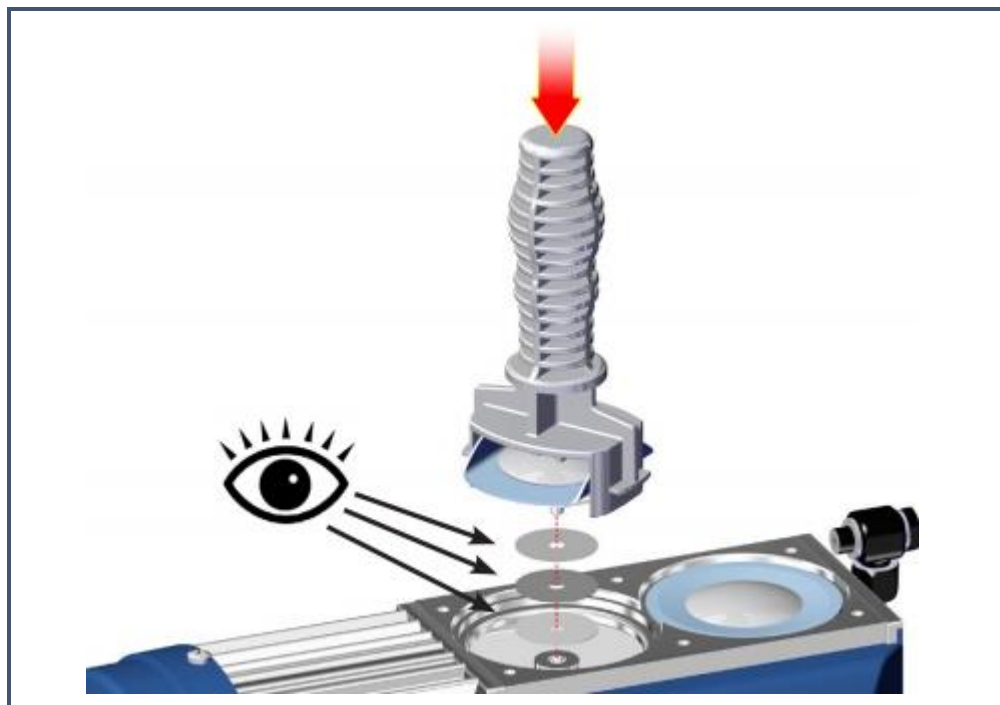

8. Apply pressure and turn the diaphragm key clockwise to secure the components.

Replacing the Valves and Assembling Pump Heads

Figure 66:
Visually inspect
diaphragms

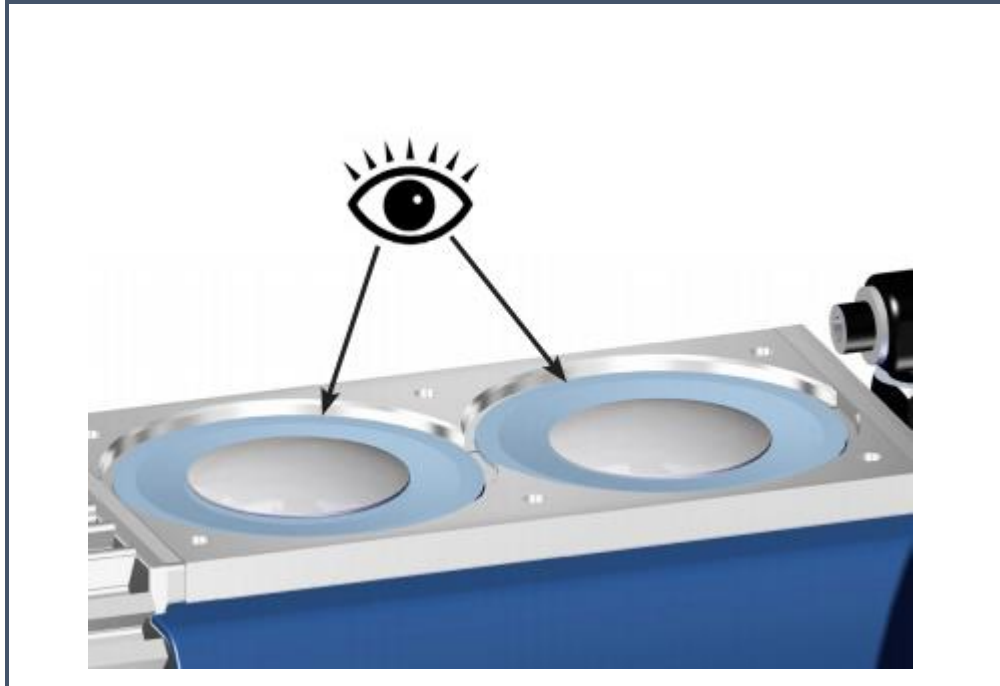

1. Visually inspect both diaphragms, they should be properly seated and locked in prior to replacing the head covers.

Figure 67:
Replace head
covers above
diaphragms

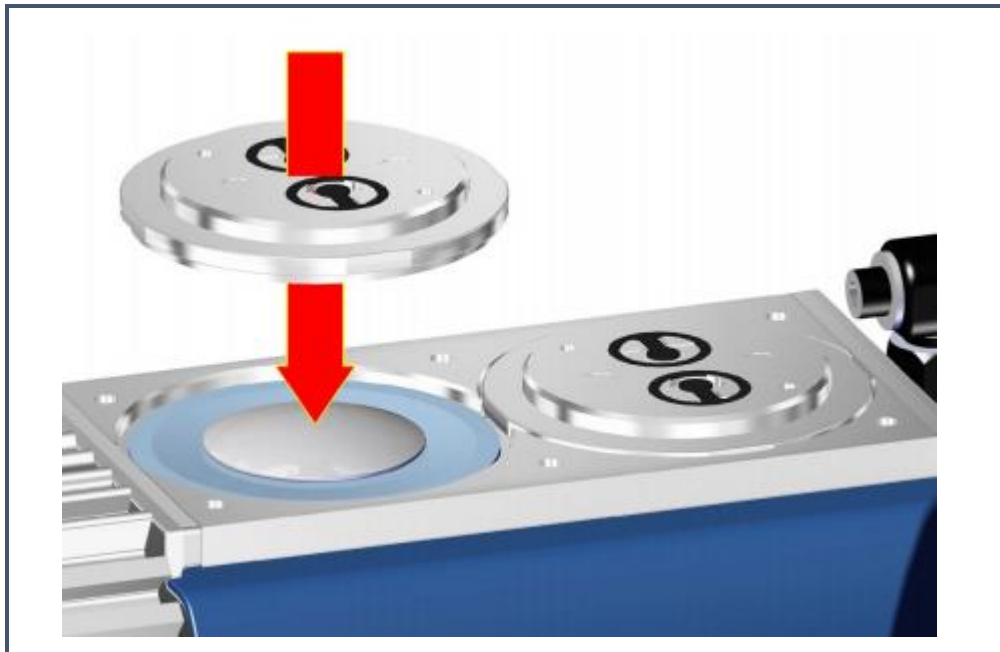

2. Replace the head covers and valves over the diaphragm clamping discs.

Figure 68:
Replace housing cover

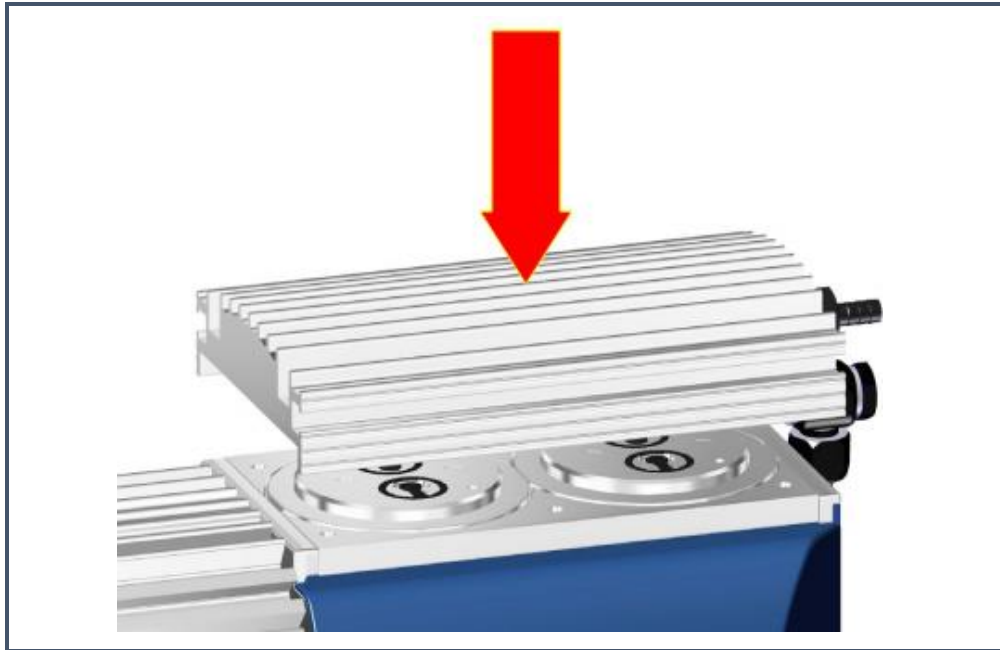

3. Replace the housing cover.
4. Align the housing cover with the screw holes in the housing.
5. Replace all six screws. Screw in manually at first and then use the 4 mm Allen key to tighten.
6. Use the 15 mm open end wrench to tighten the nut connecting the housing and housing cover.

Figure 69:
Replace handle and align screws

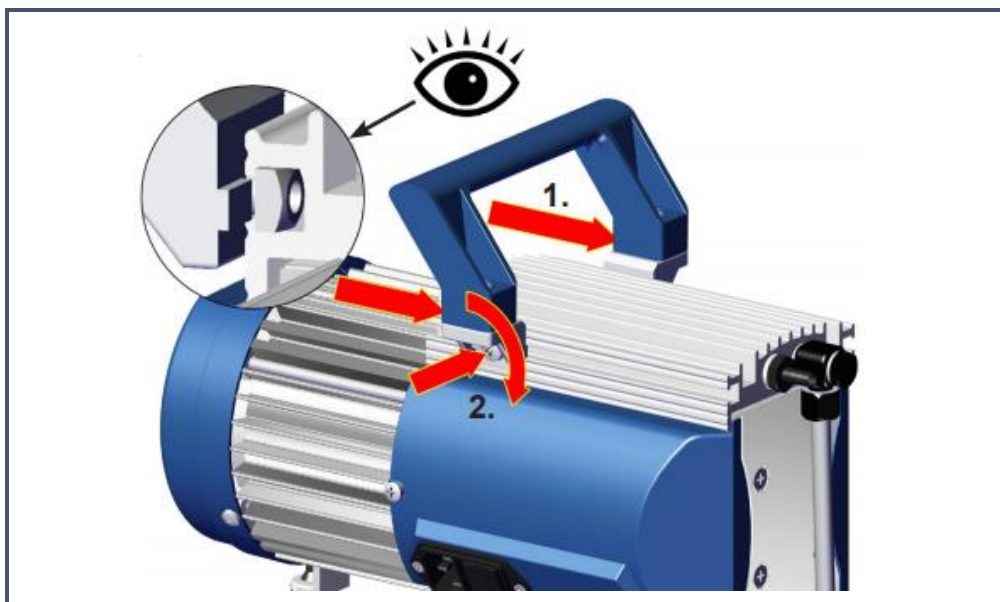

7. Reseat the handle on top of the housing cover and align the screw holes.
8. Use the size 2 Phillips screwdriver to screw and tighten both screws at the base of the handle.
9. Make sure that the edge of the handle does not hang over the edge of the housing cover as you tighten the screws.

Checking the Ultimate Vacuum

After any intervention at the equipment (e.g., repair or maintenance) the ultimate vacuum of the pump has to be checked. Only if the pump achieves its specified ultimate vacuum, the pump's leak rate is low enough to ensure that no explosive atmospheres will occur in the interior of the equipment.

If the pump does not achieve the ultimate vacuum:

- Whenever the diaphragms and valves have been replaced, a break-in period of several hours is required before the pump achieves its ultimate vacuum.
- In case of an unusual noise, switch off pump immediately and check camping disc positions.
- If the ultimate vacuum is not achieved after break-in period, check hose connectors at pump heads for leaks.
- If necessary, recheck valve seats and pump chambers.

13.6 Cleaning

Clean the outside of the analyzer with a clean dry cloth. Only certified service technicians should access or clean the inside of the analyzer.

14. TRANSPORTATION AND STORAGE

In the event that the instrument will be transported or stored, the following procedure can be used to prepare the instrument and repack it into the original carton.

Packing the Analyzer

1. Shutdown the instrument using the shutdown button, using the “prepare for shipment” option. Clean dry gas should be attached to the instrument prior to shutting down. This prevents condensation inside the system during storage or shipment.
2. Disconnect all tubing and electrical connections from the analyzer.
3. To prevent contamination and possible damage to the connector threads, place caps on all gas connections.
4. Place the analyzer in a plastic bag with a package of desiccant. Seal the bags with tape.
5. Pack the analyzer in the original shipping container ensuring that all the foam pieces are in place to protect the analyzer during shipping.



CAUTION

When shipping or relocating the analyzer, it is important to protect it from mechanical shocks. Failure to do so can compromise its performance.
When shipping the analyzer, use its original packaging only.

15. LIMITED WARRANTY

Picarro, Inc. warrants its Products to be free from defects in material and workmanship and to perform in the manner and under the conditions specified in the Product specifications for twelve (12) months from shipment.

This warranty is the only warranty made by Picarro with respect to its Products and no person is authorized to bind Picarro for any obligations or liabilities beyond this warranty in connection with its Products. This warranty is made to the original Purchaser only, is nontransferable and may only be modified or amended by a written instrument signed by a duly authorized officer of Picarro. Sub-systems manufactured by other firms, but integrated into Picarro Products, are covered by the original manufacturer's warranty and Picarro makes no warranty, express or implied, regarding such sub-systems. Products or parts thereof which are replaced or repaired under this warranty are warranted only for the remaining, unexpired portion of the original warranty period applicable to the specific Product replaced or repaired. Products or parts thereof which are replaced or repaired outside of this warranty are warranted only for ninety days.



NOTE

THE FOREGOING WARRANTY IS EXCLUSIVE AND IN LIEU OF ALL OTHER WARRANTIES WHETHER WRITTEN, ORAL OR IMPLIED, AND SHALL BE THE PURCHASER'S SOLE REMEDY AND PICARRO'S SOLE LIABILITY IN CONTRACT OR OTHERWISE FOR THE PRODUCT. PICARRO EXPRESSLY DISCLAIMS ANY WARRANTY OF MERCHANTABILITY OR FITNESS FOR A PARTICULAR PURPOSE.

The Purchaser's exclusive remedy with respect to any defective Product shall be to have Picarro repair or replace such defective Product or credit the Purchaser's account, whichever Picarro may elect in its sole discretion. If it is found that any Product has been returned which is not defective, the Purchaser will be notified and such Product returned at the Purchaser's expense. In addition, a charge for testing and examination may, at Picarro's sole discretion, be made on any Product so returned.

These remedies are available only if: i) Picarro is notified in writing by the Purchaser promptly upon discovery of a Product defect, and in any event within the warranty period; ii) Picarro's examination of such Product discloses to Picarro's satisfaction that such defects actually exist and the Product has not been repaired, worked on, altered by persons not authorized by Picarro, subject to misuse, negligence or accident, or connected, installed, used or adjusted otherwise than in accordance with the instructions furnished by Picarro.

APPENDIX A – REMOTE DATA ACCESS

The Picarro Serial Communication

The analyzer supports an RS-232 physical command interface, which can be used to control the instrument and to retrieve concentration data. Not all features of the instrument are available on the serial interface. For details on how to use the serial command interface, please see the *Picarro Analyzer Programming Guide* (included in PDF format on the installation CD). This command set may also be used across a TCP/IP interface through an Ethernet connection.

Remote Data Access

Using the *RemoteAccess.ini* file, the analyzer can be configured to automatically:

- Send data from the instrument to a list of e-mail accounts.
- Measure the offset of the host computer system clock from a set of Internet time servers and (optionally) to resynchronize the clock based on this information.

The Internet connection need not be permanent and may be a dial-up connection accessible via a user-supplied USB modem. The task of sending data and/or synchronizing the clock on the analyzer is performed using the executable program file:

C:\Picarro\G2000\HostExe\RemoteAccess.exe

This program can be set up to run periodically using the Windows task scheduler at a user-configurable frequency. If a dial-up connection to the Internet is employed, it is used only on demand to minimize the connection time.

Each time that the *RemoteAccess.exe* program runs it appends information to a log file that keeps a record of the results of the time synchronization and of the files sent by e-mail. The *RemoteAccess.exe* program is configurable by means of an initialization file, which includes information such as the login credentials for the dial-up connection, the e-mail account and the list of time servers. The initialization file is:

C:\Picarro\G2000\AppConfig\Config\UtilitiesRemoteAccess\RemoteAccess.ini

RemoteAccess.ini should be placed in the same directory as the executable program file *RemoteAccess.exe*. The file has one required section named *LOGGING* and three optional sections named *NTP*,

DIALUP, and *EMAIL*. The logging section has a single key *Logfile* whose value is the path to the log file. Once this log file exceeds 64K bytes in length, it is backed up, appending a numeric extension to the file name, and a new file is opened. A total of ten backup log files are kept.

NTP

The *NTP* section controls querying the Internet time servers using the SNTP protocol (RFC4330) and the resetting of the clock on the host computer. If the section is not present, time synchronization is not carried out.

- **Server1, Server2...:** used to specify the URLs of the time servers.
- **UpdateClock:** if key is set to “true,” the offset is applied to the host clock. Otherwise, the offset is recorded, but the host clock is not changed.

Email

The *EMAIL* section controls the sending of the data files as e-mail attachments. If the section is not present, e-mail messages are not sent. This section contains the following keys:

- **Directory:** specifies the directory that contains the data files. When the program is run, files in this directory are sent to the specified recipients and the files are deleted. To avoid problems with incomplete files, programs that place files into this directory should do so using an atomic operation, such as a rename.
- **Server:** specify an RFC2821-compliant SMTP server that sends the e-mail messages.
- **From:** specify the e-mail address from which the messages are sent. Note that some SMTP servers check that the source is permitted to send email while others allow any name in this field.
- **To1, To2...:** specify the e-mail addresses to which the e-mail is sent.
- **Subject:** fill the subject field in the email header and may be set to any string.
- **UseAuthentication:** Depending on the SMTP server, it may be necessary to use authentication before e-mails can be sent, as described in RFC2554. If such authentication is not needed, the key is set to false. If this key is set to true, two additional keys

Username and **Password** must also be specified for the e-mail account.

Dial-up

The *DIALUP* section is used if a dial-up connection to the Internet needs to be established when the program runs. If the section does not exist, a permanent connection is assumed to be available for carrying out the other tasks specified in the initialization file.

- **Connection Name:** specifies the name of the dial-up connection to use, as listed under *Network Connections* in the Control Panel. **Username** and **Password** must also be specified to make the connection.

Examples of “RemoteAccess.ini” File

[LOGGING]

Logfile=c:/temp/RemoteAccessLog

[NTP]

Server1=time-a.nist.gov

Server2=time-b.nist.gov

Server3=time-a.timefreq.bldrdoc.gov

Server4=time-b.timefreq.bldrdoc.gov

Server5=time-c.timefreq.bldrdoc.gov

Server6=time.nist.gov

Server7=time-nw.nist.gov

UpdateClock=1

[DIALUP]

ConnectionName=Picarro Dialup Access

Username=user

Password=password

Number=14085551212

[EMAIL]

Server=smtp.servername.org

Directory=c:/picarro/mailbox

From=instrument@picarro.com
To1=recipient1@site1.com
To2=recipient2@site2.com
Subject=CRDS data from Picarro instrument
UseAuthentication=0

APPENDIX B – THE DATA FILE VIEWER

The Picarro Data File Viewer software is located in the Picarro Utilities folder on the desktop. The software allows the user to graph and to conduct statistical analysis of the raw data. Additional functions include Allan Variance plot and quadratic or polynomial fittings.

The Picarro Data File Viewer includes two main menus: **File** and **New**.

Figure 70:
File Menu

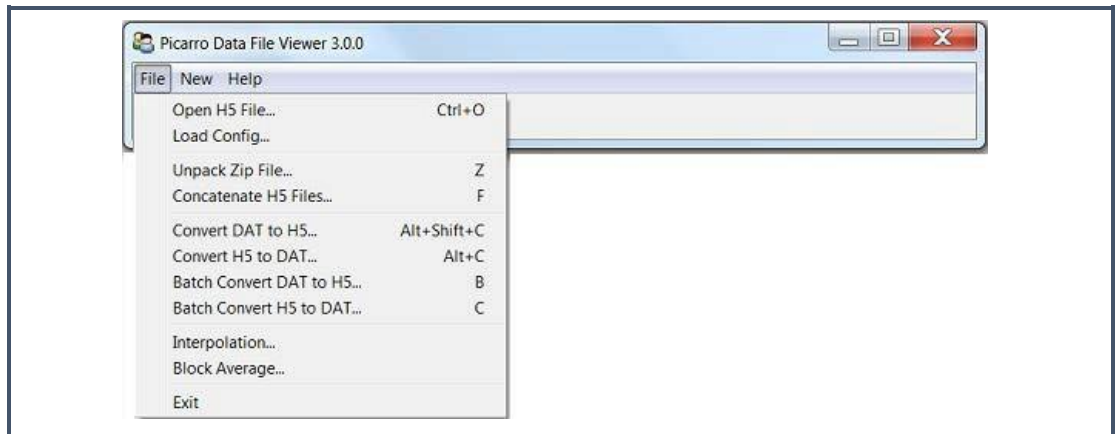
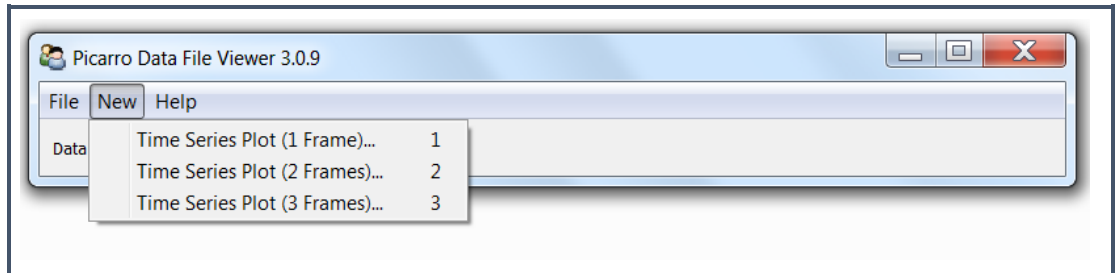

Figure 71:
New Menu



THE FILE MENU

This section describes the functions available from the Data File Viewer File menu.

Open H5

File > Open H5 opens a Picarro data file (HDF5 format) for data analysis and visualization. After opening the data file, you can create a new time series plot. Refer to *New Time Series Plot* for more information.

Load Config

File > Load Config loads a configuration file (ini format) to restore parameters of a workplace. Refer to *Save Configuration* for more information.

Unpack Zip File

Use **File > Unpack Zip File** to concatenate all H5 files inside the zip file into a single H5 file. Refer to *Concatenate H5 Files* for details.

Concatenate H5 Files

Use **File > Concatenate H5 files** to concatenate multiple files and zip archives of H5 files into a single H5 file. Navigate to the desired folder, or use the **Define date range** button to specify a date range of files to concatenate. (See next section.)

After selecting the path of the data files, Data File Viewer will automatically search an H5 file in the specified zip/folder and look for all available variables in the H5 file. The variables are then listed in the left panel, and users can use “>>” button to move variables to the right panel for concatenation.

Figure 72:
Select Variables
Form

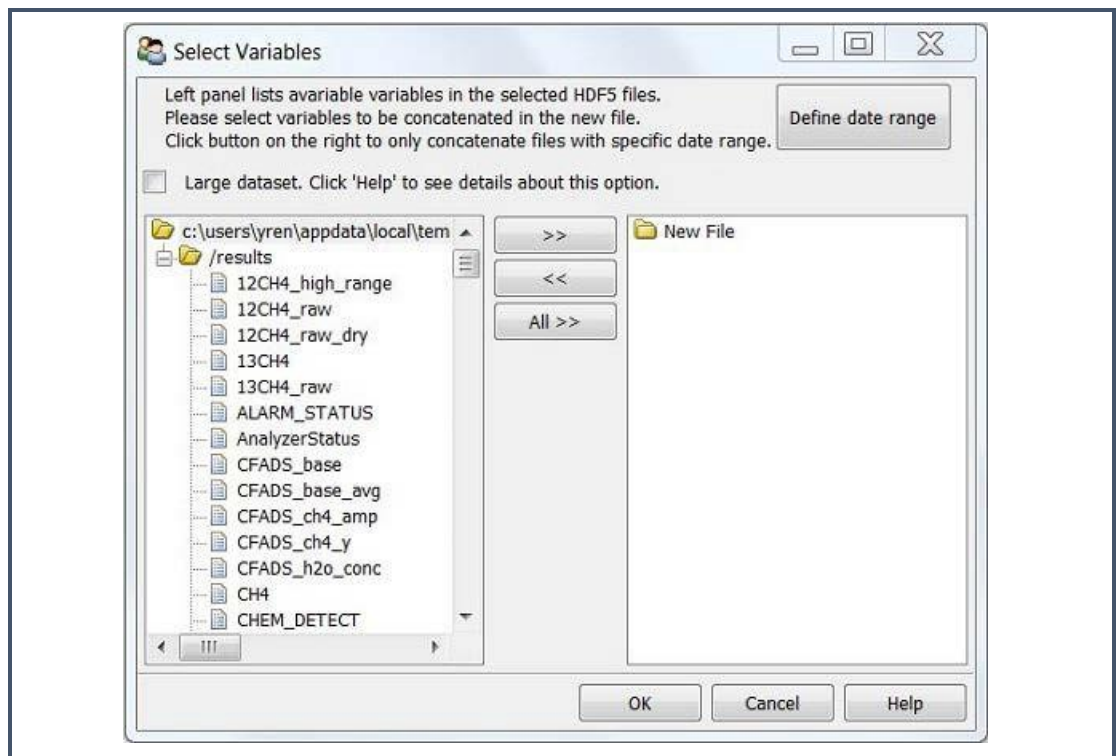

Define Date Range

Data File Viewer can search data files within the desired date range and then concatenate such files into an H5 file.

By default, *TimeZone* is set to your local time zone. However, if data were taken elsewhere, select the time zone where data were taken.

Select **File > Concatenate H5 files**, then click Define date range to specify the desired date range.

Figure 73:
Defining Date Range



Data files are saved in directory trees named by date and time option. Picarro software saves data in a directory tree that is named by the creation year, month, and day. Select this option if the target folder has this file structure. This way, Data File Viewer will only search folders within the desired date range, which can substantially reduce processing time.

Figure 74:
File Structure of Data File Viewer



NOTE

To save processing time, Data File Viewer does not open data files, but only determines data acquisition time based on the file name.



CAUTION

Do not define a time range for data files whose names have been changed.



NOTE

Data File Viewer does not concatenate data files exactly within the defined time range. This is because the time extracted from file name is different from the data acquisition time. To not miss data points, Data File Viewer expands the specified time range, so the resulting dataset normally has a wider time range than the user specification.

Convert DAT to H5

Select **File > Convert DAT to H5** to convert a file in DAT format to HDF5 format. These formats are described below:

- DAT format:** DAT files accepted by DatViewer store tabular data (numbers and text) in plain text. Each line of the file is a data record. Each record consists of one or more fields separated by whitespaces. The first line of data file indicates column names.

There must be a field “EPOCH_TIME” to store the acquisition epoch time (expressed as seconds since Jan 1, 1970) of the data. Otherwise, the first and second fields must be “DATE” and “TIME”. The “DATE” field must have the format “mm/dd/yyyy” or “yyyy-mm-dd”, and the “TIME” field must have the format “HH:MM: SS(.sss)” where (.sss) is an optional fraction of seconds.
- HDF5 format:** HDF5 is a data model, library, and file format for storing and managing data. (See the HDF5 Home Page on the HDF Group Web site for more information.) When converting DAT to HDF5 format, Data File Viewer creates a table named “results” to the contained data.

Convert H5 to DAT

Select **File > Convert H5 to DAT** to convert a file in a HDF5 format to DAT. These formats are described in *Convert DAT to H5*.



NOTE

Data File Viewer does not concatenate data files exactly within the defined time range. This is because the time extracted from file name is different from the data acquisition time. Data File Viewer expands the specified time and column name “fineLaser-Current_1_controlOn” with “fineLaserCurr_1_ctrlOn”.

Interpolation

Interpolation describes the method for constructing data points with a range of a discrete set of known data points. Select **File > Interpolation** to perform interpolation on a time grid with a constant interval.

Block Average

Select **File > Block Average** to divide a dataset into small blocks based on a user-defined block size. The average is calculated for data in each block, and the results are saved in a new H5 file.



NOTE

The specified block size must be greater than the average data interval.

Because the data interval is normally not a constant (unless interpolation is performed), fluctuations in the data interval will affect block averaging if the block size is comparable to the average data interval.

NEW TIME SERIES PLOT

You can specify to include create time-series plots with one, two, or three frames. New plots display in the Time Series Viewer.

Figure 75:
Time Series
Viewer

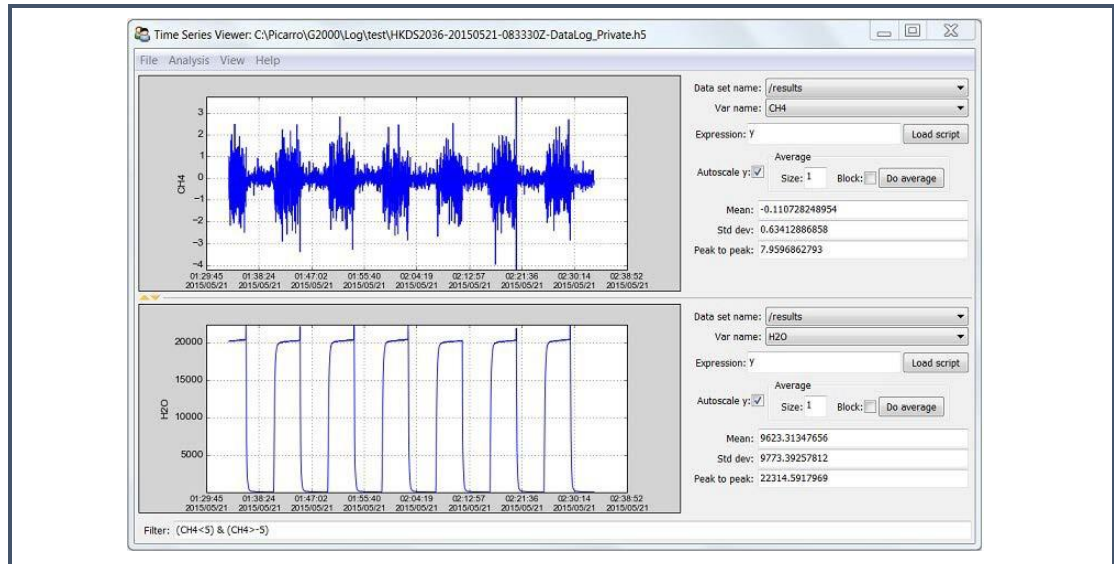

The next section describes the options available on the Time Series Viewer menu bar. Refer to *Time Series Viewer Canvas* on page 95 for information the Time Series Viewer UI features and options.

Time Series Viewer Menus

The Time Series Viewer form includes the following menus:

Figure 76:
Time Series
Viewer Menus

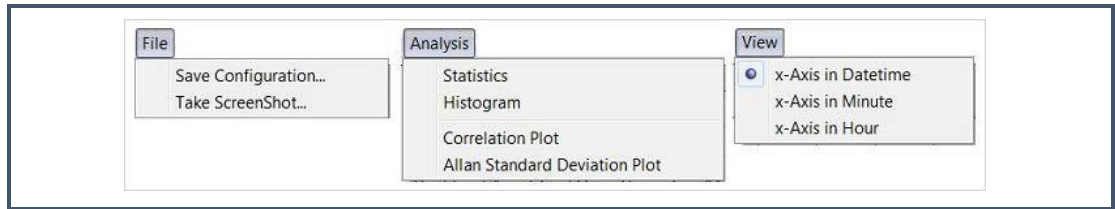

Time Series Viewer File Menu

Use the File menu to save a configuration or take a screenshot.

Figure 77:
Time Series
Viewer – File
Menu

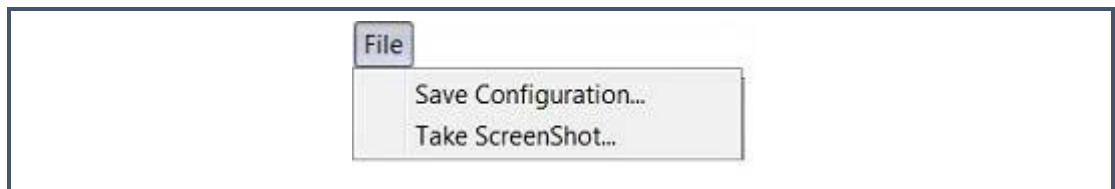

Save Configuration

Click **File > Save Configuration** to open the Feature Capture form. With this form, you can save figure properties, expressions, filters, and other settings to a configuration file so that it can be easily loaded in the future.

Figure 78:
Time Series
Viewer –
Feature Capture

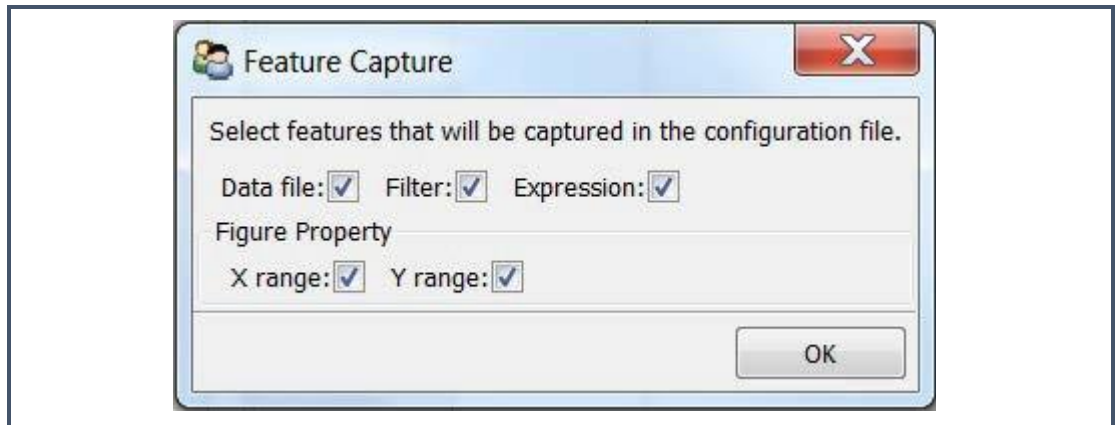

CAUTION

If a feature is not captured, it will be omitted when the configuration file is loaded.

Depending on the features captured, loading a configuration file can have different effects. For example:

- If all features are captured, a saved workplace is reproduced.

- If Data file is not captured, saved parameters will be applied to the data file in memory.
- If Expression is not captured, plots will not be transformed.
- If X (Y) range is not captured, figures will be auto-scaled on the x (y) axis.

Take ScreenShot

Use **File > Take ScreenShot** to take a screenshot of the Time Series Viewer and save it as a PNG file to a specified filename.

Time Series Viewer Analysis Menu

Use the Analysis menu to calculate statistics, generate a histogram, and to plot correlations and Allan Standard deviations.

Figure 79:
Time Series
Viewer –
Analysis Menu

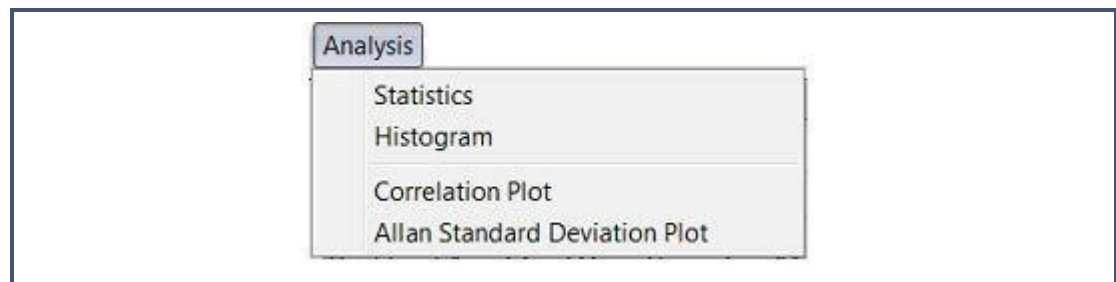

Statistics

Use **Analysis > Statistics** to calculate mean, standard deviation and peak to peak for all plots in the current window.

Histogram

Use **Analysis > Histogram** to generate a histogram of data as shown below.

Figure 80:
Histogram
Window

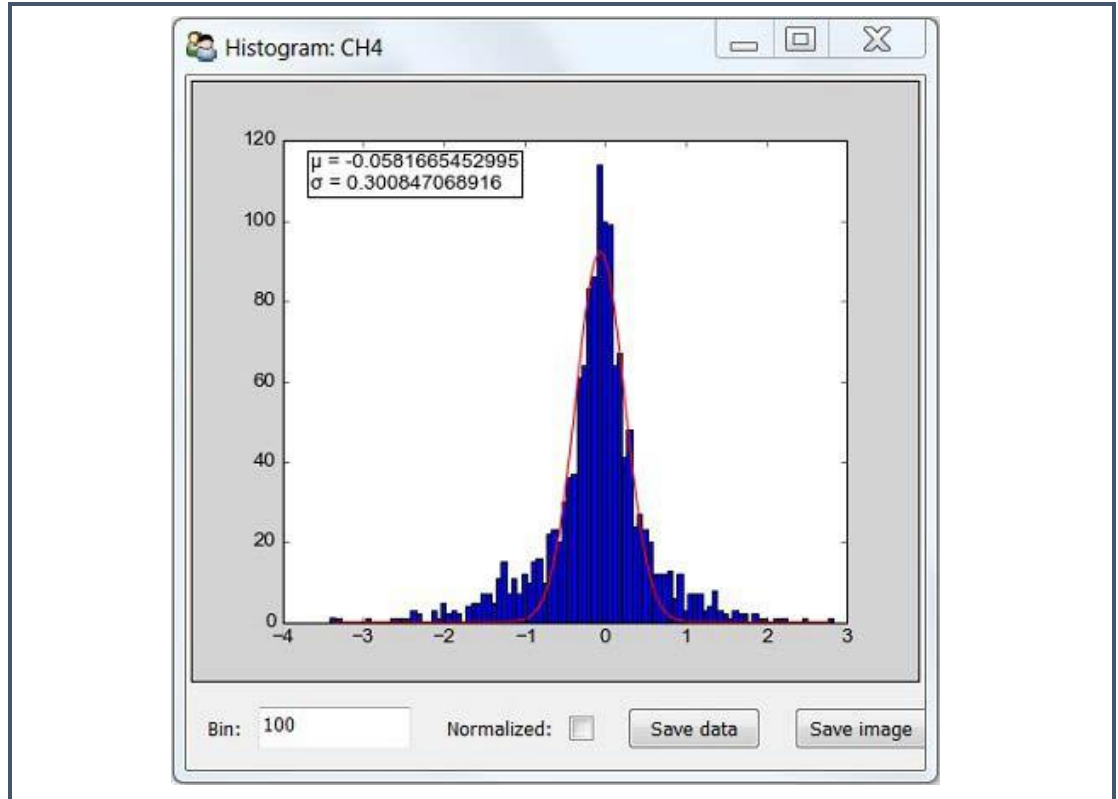

Red Line: A Gaussian function fitted to the histogram. Fitting results of μ and σ are shown in the top-left corner of the plot.

- **Bin:** Specifies the number of intervals that the range of values is divided into.
- **Normalized:** When selected, the sum of the histograms is normalized to 1.
- **Save data:** Saves histogram data to a CSV file.
- **Save image:** Saves the histogram image as a JPEG/PNG/PDF file.

Correlation Plot

Use **Analysis > Correlation Plot** to plot Y-axis data in one frame versus that in the other. This can be used when two or more frames exist in the current Time Series Plot window. See Correlation/XY Plot for details.

Allan Standard Deviation Plot

Use **Analysis > Allan Standard Deviation Plot** to create an Allan Standard Deviation plot (versus a standard deviation plot) for data in the current window. See [Allan Variance](#) for more information.

Time Series Viewer View Menu

Use the View menu to view X-axis information in date-time, minute, or hour format.

Figure 81:
Time Series
Viewer –
View Menu



NOTE

When switching from DateTime to Minute or Hour, the X-axis data is subtracted from the earliest point shown in the panel and then converted to the desired unit.

The Time Series Viewer Canvas

The Time Series Viewer canvas is comprised of interactive graphs and a variety of configuration options.

Figure 82:
Time Series
Viewer Canvas

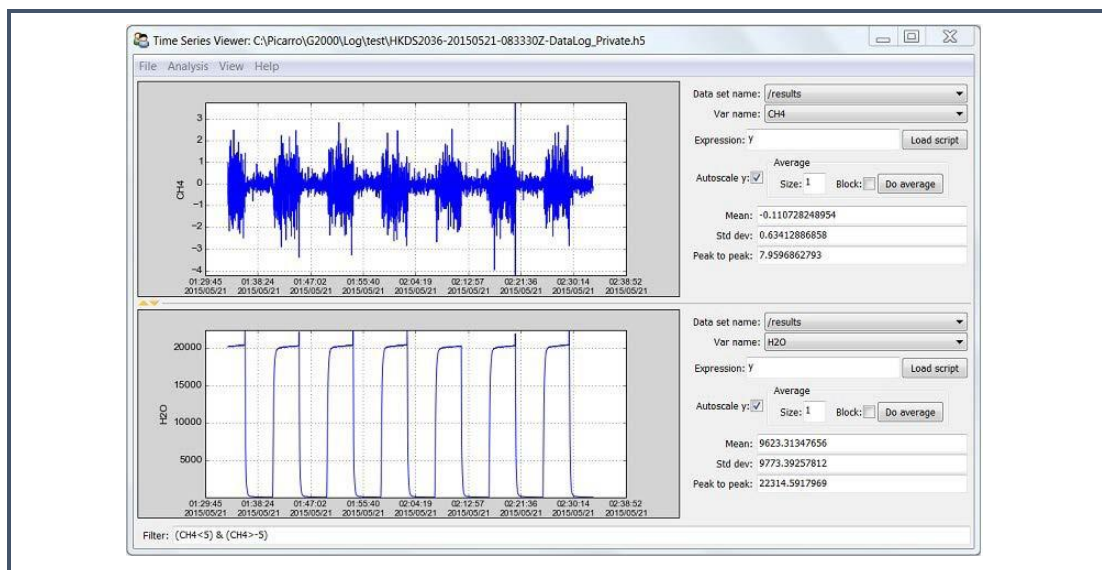

Mouse Options and Graph Transform

The following mouse actions can be used in the canvas graphs:

- Left click and drag: Zooms into the selected area of the plot.
- Left click and drag with the SHIFT key down: Pans the plot.
- Left click and drag with CTRL key down: Zooms out from the plot.

- Left click and drag with ALT key down: Stretches the plot.
- Right-click: Opens an additional menu. Refer to the next section.

Right-click Menu

Right-clicking on the canvas provides opens a pop-up menu.

Figure 83:
Canvas Right-click Menu

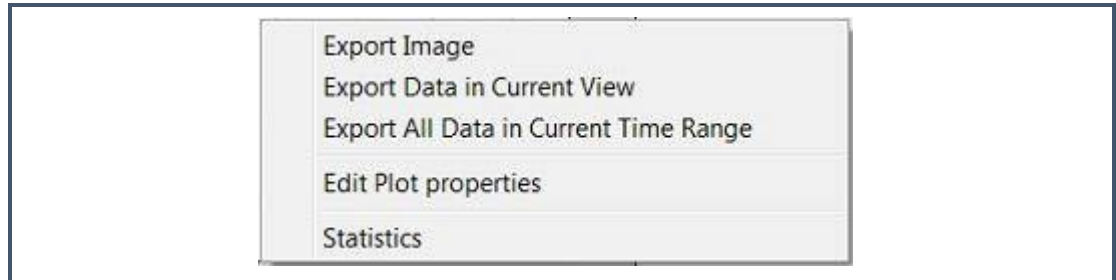

Export Image: Exports the current plot as a JPEG, PNG, or PDF file.

Export Data in Current View: Exports only date/time and the selected variable in the current view to an HDF5 or CSV file.

Export All Data in Current Time Range: Exports all variable columns of the selected dataset in the current time range to an HDF5 file. Refer to *Concatenate H5 Files* on page 88 for more information.

Edit Plot properties: Opens the Image Editor form, where the following options can be specified:

- **Title:** Edits the title of the plot.
- **Line:** Specifies the line pattern of the plot. If **None** is selected, the data points will be plotted without connecting lines.
- **Marker:** Specifies the marker type to indicate data points. If **None** is selected, data points will not be shown.
- **Min and Max:** Specifies the minimum and maximum of data range for the X-axis and the Y-axis.
- **x[0]:** Sets the earliest time of the dataset as the minimum of the X-axis.
- **Time zone:** Sets the time zone for date/time variables. This defaults to the local time zone.
- **Label:** Specify a label for the X-axis and the Y-axis.

Figure 84:
Image Editor
Form

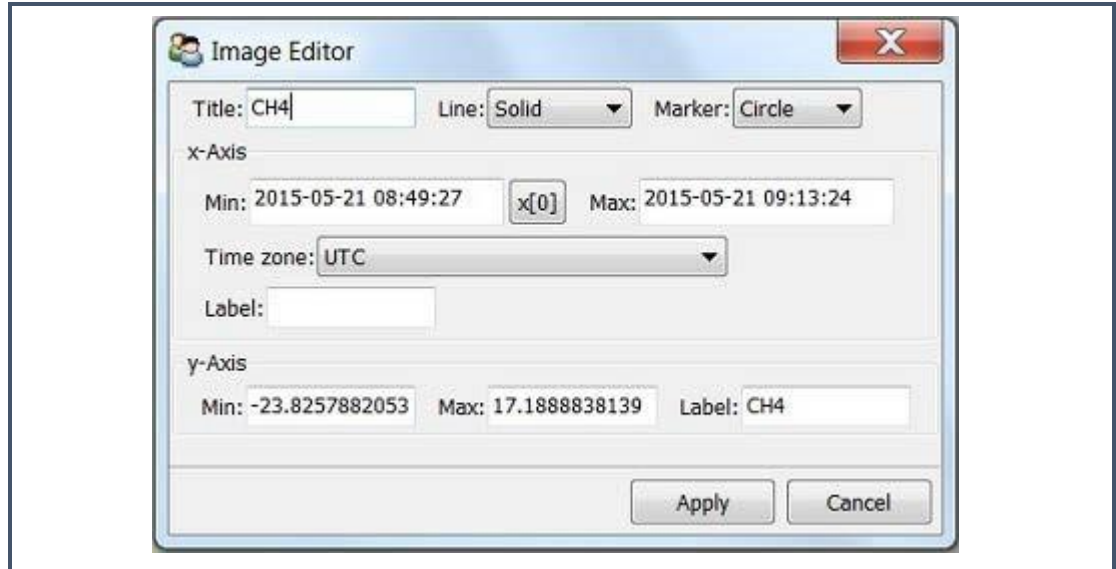

Statistics: Calculates the mean, standard deviation, and peak to peak for data in the current view.

Dataset Name and Var Name

An HDF5 file can store one or more tables. Each of these tables is called a Dataset. A table can contain one or more columns. Each column is called a variable (Var).

Use the **Dataset name** drop down menu to select the dataset that will be used for this time series graph. Use the **Var name** drop down to select the column in the dataset to use in the graph.

Autoscale Y

When the Autoscale Y option is selected, the Time Series Viewer will autoscale on the Y-axis to make sure that all data within the range of the X-axis is displayed.

Average

If **Block** is selected, a block average is calculated when you click the Do average button is clicked. Otherwise, a moving average is calculated.

For a block average, **Size** specifies block size in unit of a minute. For a moving average, **Size** specifies subset size in unit of data points.



REMINDER

Averaging is performed after the Filter and Expression are performed.

Mean, Std Dev, and Peak to Peak

The **Mean**, **Std dev** (Standard deviation) and **Peak to peak** fields provide all the statistical information of data in the current view.

Correlation/XY Plot

The Correlation/XY Plot window includes two menu items: **File** and **Analysis**. For details about the File menu, see *Save Configuration* on page 92.



REMINDER

The canvas in this plot is interactive. For details about the plot canvas, see *The Time Series Viewer Canvas* on page 95.

Figure 85:
Correlation/XY
Plot

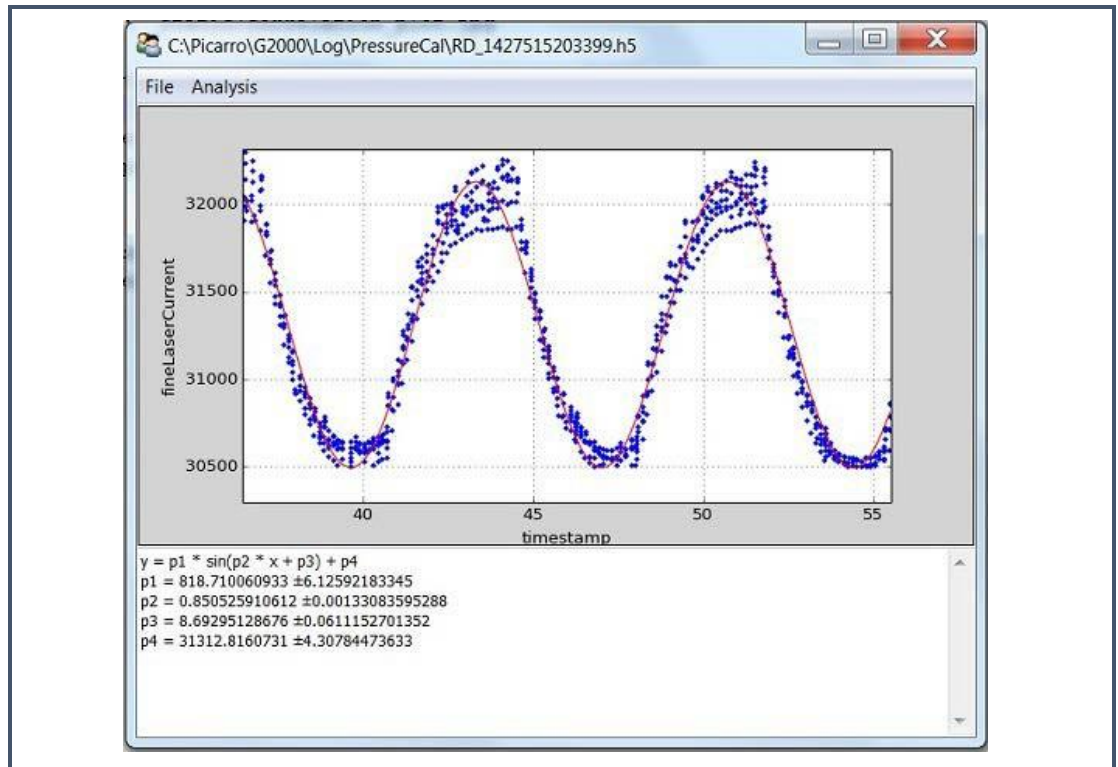

Analysis Menu

The Analysis Menu includes three options:

- **Fitting** allows you to specify one of four fitting methods to include in the Correlation/XY plot:
 - i. **Linear fit:** Specifies to fit to linear function $y = c_1x + c_0$
 - ii. **Quadratic fit:** Specifies to fit to quadratic function $y = c_2x^2 + c_1x + c_0$

- iii. **Polynomial fit:** Specifies to fit polynomial function of degree n : $y = \sum c_n x^n$
- iv. **Curve fit:** Specifies to use non-linear least squares to fit an arbitrary function to data.

Figure 86:
Analysis
Menu

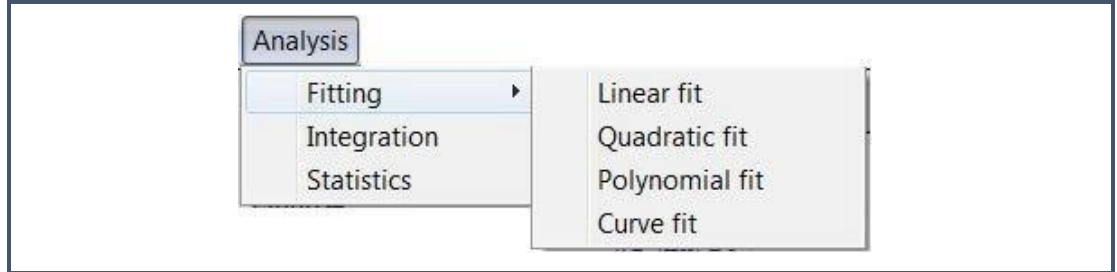

- **Integration** calculates area under the curve using the composite trapezoidal rule.
- **Statistics** calculates mean, standard deviation, and peak to peak for data in the current view.

After applying any of the above Analysis options, the results, statistics, or fitting function with coefficients are displayed in the lower portion of the Correlation Plot window.

Figure 87:
Results of
Quadratic
Fitting

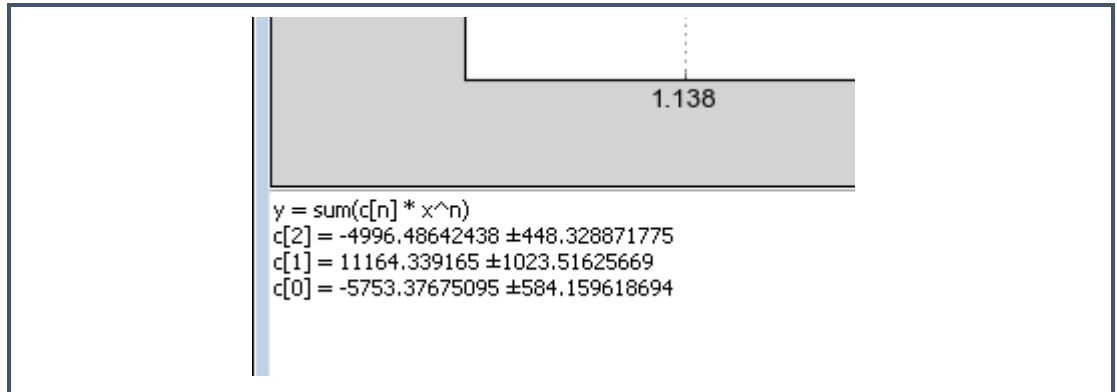

APPENDIX C – EXTERNAL VALVE SEQUENCER

The Picarro analyzer can control two types of valves:

- **Solenoid valve(s):** DC voltage powered valve with normally open (NO) and normally closed (NC) positions. These can be either 2-way or 3-way valves.
- **Rotary Selector valve:** digitally controlled valve used to send selected flow from one of many inputs (up to 32) into the analyzer

Both types of valves can be simultaneously controlled through a common software interface called the 'External Valve Sequencer,' which is available from the Tools menu in the GUI.

Default Configuration

For all models of Picarro analyzers, the rotary valve control is disabled in the factory default setting. The solenoid valve control, however, is ready to use by default for all solenoid valve connectors.

Setting Up Solenoid Valves

The Valve Sequencer software can control up to six solenoid valves. Each valve should operate using 12 VDC with a current requirement of <1.5 Ampere maximum. This analyzer comes with a cable that can be connected to the solenoid valves.

The valve connector cable should be connected to the 15-pin connector at the lower left corner of the analyzer. There are six pairs of wires with connectors labeled V1, V2, ... V6 with 2-pin female Molex connectors (Molex#43020-0200) for connection to the solenoid valves. For valves wired with matching Molex connectors, connect V1 to the solenoid valve 1, V2 to solenoid valve 2, etc. Do not connect the solenoid valve to the analyzer ground -- use only the provided electrical connectors.

Setting Up Rotary Selector Valve

A multi-position rotary selector valve can be controlled by the Valve Sequencer software. It is controlled by standard serial commands in the Valco (VICI) protocol. Valco rotary valve models SD, SC, SF, ST, and STF are all supported. However, not all configurations will be appropriate, due to tube diameter, pressure or materials of construction. This setup will also require a Valco micro electric high torque actuator. A single combination package such as EMT2ST16MWE includes a 16 position, low- pressure

ST valve in stainless steel, 1/8" tubing, 2" standoff, and micro electric high torque actuator. Please refer to http://www.vici.com/vval/st_8-1.php#16pos for further options and consult with Valco directly for more details.

The Valco controller should be installed per manufacturer's instructions. The 9-pin female, connector cable (female) should mate with its corresponding, male port of the analyzer and labeled "MPV." Please note the 9-pin connector cable is not supplied with the instrument.

Figure 88:
8-port Valve
Setup

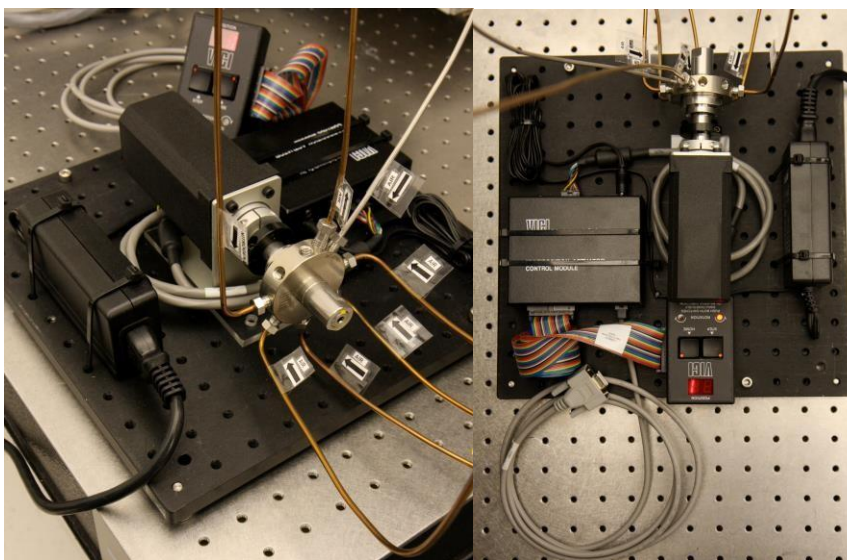

Valve Sequencer Software

The Valve Sequencer software allows the user to set steps in which solenoid valves are turned on/off and the rotary selector valve is set to a single position. The Picarro valve sequencer window appears below:

Figure 89:
Valve
Sequencer GUI

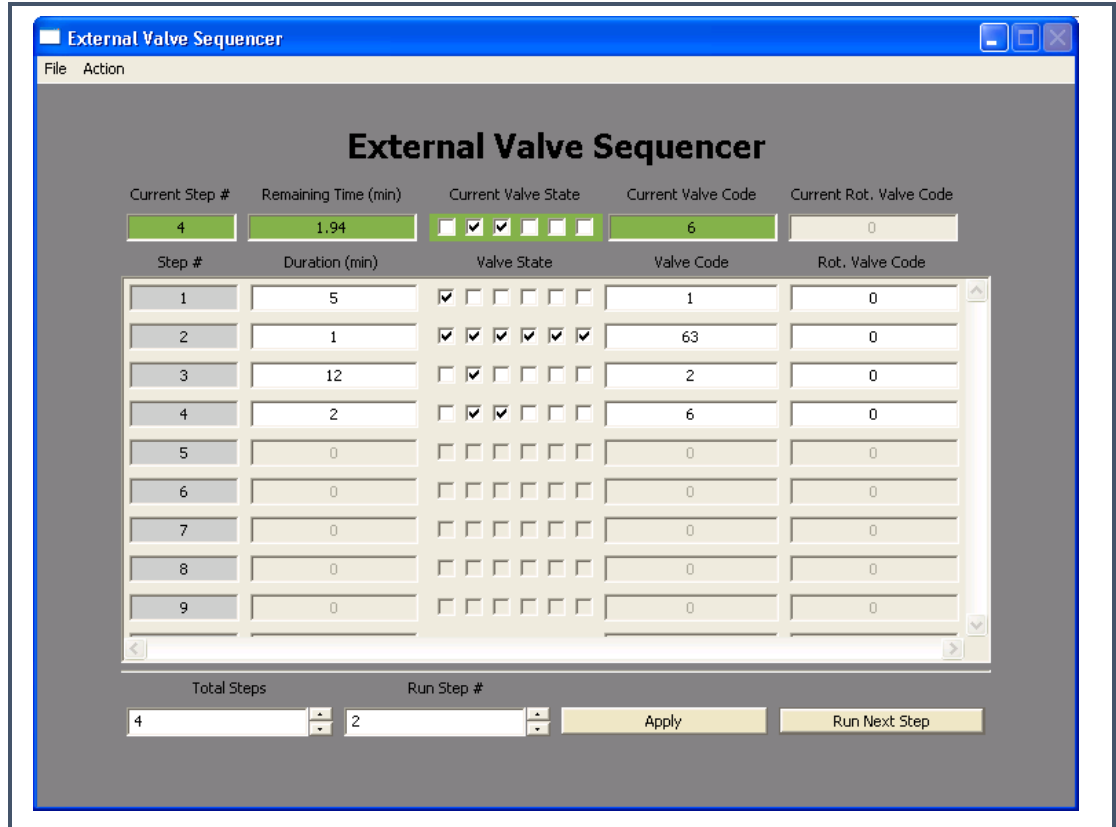

The current step, elapsed duration, and valve states are shown in the topmost row of the valve sequencer command window. The duration of each step is set in minutes; for example, 1 minute and 30 seconds correspond to 1.5 minutes.

Please note the number of steps correlates with the total steps in the sequence, and the count of the steps starts at “0.” The first step in the sequence is designated Current Step “0,” and the second step in the sequence is designated Current Step “1.” The “Go to First Step” menu item under “Action” restarts the sequence from step 1.

Different sequences can be created and saved in the software. Use the “Sequence File #” field to select which file the sequence will be saved to (0 to 10 are the available choices). Click the up/down arrows to select the desired number.

Configuring a Valve Sequence

Each “step” sets the rotary valve to a single position and activates the indicated solenoid valve(s) for a set period. Multiple steps can be carried out in sequential order to switch between different gas sources, flush out a manifold, or other gas handling operation. Create the number of desired steps in the sequence by clicking the up/down arrow for “steps.”

For each step, select the box for each solenoid valve to be opened. The checkmark in the “current valve state” window indicates a solenoid valve is open. Note: In this example, we assume normally closed (NC) valves are used. A check indicates current is flowing to the valve thus powering it open. The positions from left to right correspond to solenoid valves V1...V6.

The rotary selector valve position can be set in the column labeled “Rot. Valve Code.” Enter the number that corresponds to the desired valve position. A value of 1 in this field corresponds to position 2 on the Valco valve. Only one rotary position can be selected per step.

Step duration is determined by the value entered in the “duration (min)” field, where the duration of the step is in minutes. If duration values are set to <0.1 minutes, they may not be carried out correctly.

The “valve code” field is a configuration- dependent, read-only display field that shows the total state of that particular step in a numerical code. Should the most upper right gray box display a value of 512,256 or be grayed-out, either no rotary selector valve is connected to the instrument, or the valve is not functioning. For each individual measurement, the analyzer makes, the valve codes and rotary valve positions corresponding to the valve state(s) at that point in time are saved alongside the concentration data.

Once the valve sequence has been programmed, it can be saved using the button “Save Valve Sequence File.” The sequence will be saved under the sequence file number selected.

Loading and Running a Saved Sequence

To load a valve sequence file, select the desired “sequence file number” and press “Load Valve Sequence File.” If the user has been running a different sequence from the one that was loaded, the user needs to press “Next Step” to initialize the newly selected sequence.

To run a sequence file, press “Enable Sequencer.” This button will turn to “Disable Sequencer” once the sequence starts. (The sequencer should be activated if it was disabled, but not necessarily to change from one sequence to another.) The sequence will repeat itself indefinitely until

disabled or the software is exited. If enabled, the sequence will continue to run after the “close sequencer window” button is pressed.

If desired, the valve sequence can be forwarded to the next step of the sequence by pressing the “run next step” button. To stop the sequencer file, use the “Start/Stop Sequencer” menu item under the “Action” menu. This will leave all valves in their current state. In some situations, it is convenient to program the last step in the sequence to be a safe or default valve state. The sequencer can be advanced to the last step should the user need to put the solenoid or rotary valves into a safe/default state. The “Reset All Valves” de-activates all valves. Using the “Hide Sequencer Interface” closes the window, but if the sequencer is enabled, it will continue to run in the background. To jump to a particular step, increment the “run step 3” and click “Apply.”

Both solenoid and rotary valve codes are recorded in columns in the output data files indicating the active valve configuration respective to when data is taken. These codes can be used as event timing flags. For example, if no solenoid valves are present, the codes will be recorded regardless of whether a valve is connected or not.