

PICARRO

A0702 Closed System Measurement Package User Manual



Picarro Inc.
3105 Patrick Henry Drive
Santa Clara, CA 95054, USA
Phone: +1 408 962 3944
www.picarro.com

Document Number 40-0050 Revision D

Picarro Notices

Thank you for purchasing a Picarro product. Your Picarro A0702 is a quality product that has been designed and manufactured to provide reliable performance.

This manual is an important part of your purchase as it will help familiarize you with the module and explain the features that have been designed into it. Please read this manual thoroughly before using the module.

Please contact Picarro or your authorized Picarro distributor if you have questions regarding specific applications or if you require additional information.

DISCLAIMER AND RESERVATION OF RIGHTS

Picarro has prepared this manual solely for the information and use by its customers as a guide for the selection, installation, operation, and maintenance of the products described.

EXCEPT AS PROVIDED IN THE TERMS AND CONDITIONS OF SALE FOR PICARRO PRODUCTS, PICARRO ASSUMES NO LIABILITY WHATSOEVER, AND PICARRO DISCLAIMS ANY EXPRESS OR IMPLIED WARRANTY, RELATING TO SALE OR USE OF PICARRO PRODUCTS, INCLUDING LIABILITY OR WARRANTIES RELATING TO MERCHANTABILITY OR FITNESS FOR A PARTICULAR PURPOSE.

Picarro reserves the right to change or update the contents of this manual and the specifications of its products at any time, without notice. Picarro has endeavored to include information that is current and accurate as of the date of the publication or revision of this document, but Picarro does not guarantee that this document is error free or that it is accurate with regard to any particular specification.

Picarro expressly reserves all intellectual property rights, including all intellectual property rights relating to any product described in this manual. This document does not grant any license, express or implied, by estoppel or otherwise, to any intellectual property rights of Picarro or any third party.

PATENTS

The products described in this manual are subject to Picarro patents and patents pending. Information about Picarro patents applicable to these products is available at www.picarro.com/company/patents

TRADEMARKS

Picarro and the Picarro logo are trademarks of Picarro, Inc.

Swagelok® is a trademark of Swagelok Company

Snoop® is a trademark of Swagelok Company

Eosense® is a trademark of Eosense, Inc.

EosAC is a trademark of Eosense, Inc.

eosMX is a trademark of Eosense, Inc.

Copyright © 2022 Picarro, Inc. All rights reserved

Contact Information

Please contact Picarro for questions regarding specific applications and additional information.

General Technical Support:

Email: support@picarro.com

Phone: + 1 408 962 3991

European Technical Support:

Email: support@picarro.com

Phone: +31 85 888 1650

Customer Service:

Email: orders@picarro.com

Phone: + 1 408 962 3992

Table of Contents

| | |
|---|-----------|
| Picarro Notices | 2 |
| Contact Information | 3 |
| Table of Contents | 4 |
| List of Figures | 6 |
| List of Tables | 7 |
| 1. Introduction | 8 |
| 1.1 Intended Use | 8 |
| 1.2 Description | 9 |
| 1.3 A0702 Specifications | 10 |
| 1.1 Acronyms | 11 |
| 1.2 Text Conventions | 11 |
| 2. Safety | 12 |
| 2.1 Warning Symbols | 12 |
| 2.2 General Safety | 13 |
| 3. Unpacking | 14 |
| 3.1 Shipping, Handling and Storage | 14 |
| 3.2 Inspect the Shipping Box | 14 |
| 3.3 Unpack the Shipping Box | 14 |
| 4. Installation and Initialization | 16 |
| 4.1 Installation Safety | 16 |
| 4.2 Tools Required (Not supplied) | 17 |
| 4.3 Connection Overview | 17 |
| 4.4 Pump to Analyzer Connections | 18 |
| 4.5 Initialization | 20 |
| 4.6 Setting up Recirculation | 21 |
| 4.7 Calculating Fluxes | 22 |
| 5. Instrument and Pump Leak Test | 23 |
| 5.1 Introduction | 23 |
| 5.2 Leak Test Procedure | 24 |

6. Maintenance..... 25

 6.1 Fuse Replacement..... 25

 6.2 Cleaning..... 25

APPENDIX A – Swagelok VCR Fitting Instructions..... 26

List of Figures

Figure 1: A0702 Front Panel 9

Figure 2: A0702 Back Panel..... 9

Figure 3: Shipping Box Contents..... 15

Figure 4: A0702 Connection Schematic..... 17

Figure 5: Inserting New Gasket into VCR Female Fitting 18

Figure 6: Tightening Vacuum Adapter Fitting 19

Figure 7: VCR to Analyzer Adapters – Ensure Proper Alignment and
Tightness 20

Figure 8: 1/4” VCR to 1/8” NPT Male Adapters (shown with and without
temporary endcaps) 21

Figure 9: Configuring for A0702 Closed System Leak Test..... 24

Figure 10: Fused Power Connector..... 25

Figure 11: Fuse Replacement 25

Figure 12: Making a VCR Connection 26

List of Tables

| | |
|--|----|
| Table 1: A0702 Specifications..... | 10 |
| Table 2: Acronyms, Formulas, Units, and Symbols..... | 11 |
| Table 3: Warning/Information Icon Types..... | 12 |
| Table 4: Box One Contents | 14 |
| Table 5: Box Two Contents | 15 |

1. Introduction

1.1 Intended Use

The Picarro A0702 Closed System Pump module, together with a Picarro analyzer, provides high-precision concentration and isotope ratio measurements for experiments conducted in closed, recirculating systems.

The A0702 closed system measurement package recirculates samples through the analyzer cavity in a closed loop with minimum leakage. This makes it ideal for monitoring gas evolution from soils or vegetation or the incorporation of stable isotope labels into living organisms.

Compatibility

Currently the A0702 recirculation pump is compatible only with instruments configured with the A0701 sample handling materials upgrade. This is configured by default on G2308, G2508 and G2201-i instruments and can be added to many other instruments. The user should check with their sales representative before purchasing the A0702 kit to request this configuration upgrade, and/or confirm it is compatible with the instrument they have chosen.

Additional analyzers with sticky or reactive gases like H₂O₂, HCl, HF, H₂S, Formaldehyde, and Ethylene Oxide are not configured for and have not been tested with the A0702.

Picarro has not tested ammonia measurement accuracy on the G2508 analyzer using the A0702 recirculation pump.

The G2509 Fast Ammonia analyzer is not currently compatible with recirculation.

1.2 Description

Figure 1 shows the recirculation pump front panel and Figure 2 shows the recirculation pump back panel.



Figure 1: A0702 Front Panel

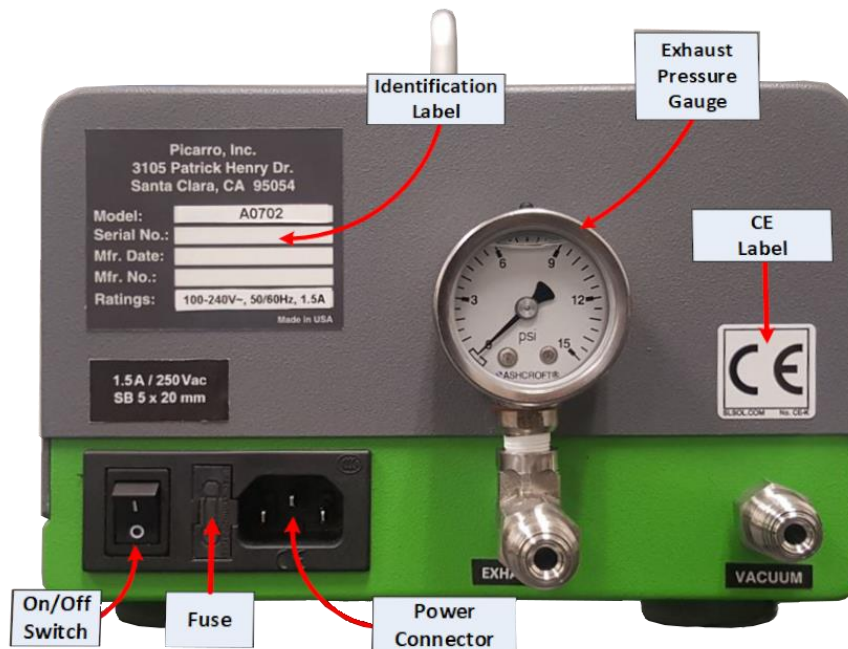

Figure 2: A0702 Back Panel

1.3 A0702 Specifications

Table 1: A0702 Specifications

| Parameter | Specification |
|----------------------------------|--|
| Weight | 9.8 lb. (4.5 kg) No special lifting precautions are required. One person may lift this pump. |
| Dimensions | Length 13.5" (34.29 cm) Width 7.5" (19.1 cm) Height 5.5" (14 cm) |
| Temperature Range | Storage: 0 °C to 70 °C Operation: 0 °C to 45 °C |
| Ambient Humidity Range | <85% R.H. non-condensing |
| Leak Rate | < 0.05 sccm over 12 hours |
| Maximum Altitude | 10,000 ft (operation) |
| Side Clearance for Ventilation | 2 inches |
| Power Requirements | 100 to 240 VAC, 50 to 60 Hz (auto-sensing) 60 W (at start-up); 60 W (during operation) |
| Power Supply Voltage Fluctuation | +10% of nominal voltage |
| Liquid Ingress Protection | None |
| Fuse Rating | 1.5 A at 250 VAC, 5 mm x 20 mm, slow blow |



Setup Requires a gas tight sample chamber, including lids and seal. Use only Picarro supplied bellows tubing and fittings. Using other tubing and fittings may degrade performance and will change total system volume. See Section 5, Instrument and Pump Leak Test for information on ensuring leak-free performance.

1.1 Acronyms

This manual may include various acronyms. For definitions, see below:

Table 2: Acronyms, Formulas, Units, and Symbols

| Acronym | Definition |
|----------------|--|
| CRDS | Cavity Ring-Down Spectroscopy |
| DAS | Data Acquisition System (the Analyzer) |
| GUI | Graphical User Interface |
| cm | centimeters |
| mm | millimeters |
| " (as in 1/4") | Inches |
| °C | Degrees Celsius |

1.2 Text Conventions

The following conventions are used in the manual.









- *Italic* text identifies screen names and to emphasize important text or certain features.
- ***Bold Italic*** text identifies section reference links.
- **Bold** text is for actions to take (such as clicking on a UI button), caution and warning statements, and text you should type or select in screens.

2. Safety

2.1 Warning Symbols

Icon notes and warnings are used throughout this manual. The purpose of these icons is to provide a visual convention to alert you important information. They indicate dangers to either the operator or to the analyzer, and other important information.

Table 3: Warning/Information Icon Types

| Icon | Description |
|---|---|
|  NOTE | NOTE is important information that you should be aware of before proceeding. |
|  WARNING | LASER WARNING alerts you of a laser danger. |
|  DANGER | DANGER indicates an imminently hazardous situation that, if not avoided, will result in death or severe injury. |
|  WARNING | WARNING indicates a potentially hazardous situation which, if not avoided, could result in death or severe injury. |
|  CAUTION | CAUTION alerts user of a potential danger to equipment or to the user. |
|  WARNING | HAZARDOUS VOLTAGE alerts user to areas that may expose a user to electrical energy that is high enough to cause injury or death. |
|  CAUTION | HOT SURFACE alerts user to potential injury from hot surfaces. |
|  REMINDER | REMINDER is a helpful hint for procedures listed in the text. |

2.2 General Safety

CE Certification

This Picarro product complies with the European standards and the instrument is affixed with a CE label. This CE label is located on the rear of the instrument.



WARNING

Using the A0702 in a manner not specified by Picarro may result in damage to the unit and render it unsafe to operate.



WARNING

The A0702 is for indoor use only and has an ingress protection rating of IPx-0. It is NOT protected against exposure to water including dripping, spraying, splashing or immersion.



WARNING

Do not operate in an explosive atmosphere. Do not operate in the presence of flammable gases or fumes.



CAUTION

The A0702 contains no user serviceable components except the Fuse. Do not attempt any repairs. Instead, report all problems to Picarro Customer Service or your local distributor. Please contact Picarro if you have any questions regarding the safe operation of this equipment.



CAUTION

Only authorized persons may open the A0702 cover or perform internal maintenance. Contact Picarro for maintenance instructions and maintenance kits. Unplug the A0702 before working with the internal components. Failure to do so may result in electric shock or electrocution or can damage the unit.



CAUTION

The inlet gas connector on the back panel of the associated analyzer and its immediate vicinity runs hot during operation of the analyzer. Use caution when connecting the gas line from the A0702 or when working at the rear of the analyzer. Wear protective gloves or avoid contact with these surfaces.

3. Unpacking

3.1 Shipping, Handling and Storage

- Picarro equipment may be transported in non-pressurized aircraft.
- Do not store boxes outside in the rain or in extreme heat or cold.
- Handle Picarro equipment with care. Do not drop or shake boxes.
- Do not stack boxes more than five high.

3.2 Inspect the Shipping Box

Picarro products are inspected and tested before leaving the factory. The shipping boxes provide proven safety from most dropping, crushing or spiking events.

If the equipment arrives damaged, photograph the damages and contact Picarro (email pictures if possible) for consultation on best course of action.



NOTE

Save the original shipping materials for re-use when storing or shipping the unit.

3.3 Unpack the Shipping Box

Unpack the shipping box. It contains the following:

Table 4: Box One Contents

| Item (qty) | Description |
|---|---|
| A0702 Vacuum Pump (1) | Used with the G2308 and G2508 instruments to measure gas concentrations in a recirculating closed system. |
| Ni/Ag gaskets (10) | Gaskets for VCR connections |
| A/C Power Cable (1) | For pump power |
| 1/4" VCR to 1/4" Tube Fitting Adapter (1) | For connection to analyzer Sample Inlet |
| 1/4" VCR to 3/8" Tube Fitting Adapter (1) | For connection to analyzer Vacuum Inlet (comes as two connected, but not tightened adaptors) |

| Item (qty) | Description |
|---|--|
| NPT 1/8" Male to 1/4" VCR Male Adapter, (2) | For connections to sample chamber Inlet and Outlet |
| Swagelok VCR Manual (1) | |
| Pump User Manual (1) | A0702 Closed System Measurement Package User Manual (PN 40050) |

Table 5: Box Two Contents

| Item (qty) | Description |
|--------------------|--|
| A0702 Vacuum Lines | Vacuum lines for A0702 recirculation pump: 24" flexible stainless-steel bellows tubing VCR, 1/4" OD (Qty 2) 12" flexible stainless-steel bellows tubing VCR, 1/4" OD (Qty 1) |

Figure 3 shows all items minus the power cable.



Figure 3: Shipping Box Contents

4. Installation and Initialization

4.1 Installation Safety



WARNING

Using this system in a manner not specified by Picarro may result in damage to the analyzer or pump and render it unsafe to operate.



CAUTION

Use the AC power cables supplied with the A0702 or a similarly rated cable. Contact Picarro technical support if you have questions about power cable replacement. Inadequately rated power cables can result in equipment damage.



WARNING

Do not attach electrical power to or start the analyzer until *after* attaching and turning on the pump. Do not disconnect the vacuum line while the analyzer is running. Failure to do so could result in damage to the optics.



CAUTION

If the A0702 has been stored at less than 10 °C, allow the components to equalize to room temperature before starting the installation process.



CAUTION

The A0702 is for indoor use only and has an ingress protection rating of IPx-0. The A0702 is NOT protected against exposure to water including dripping, spraying, splashing or immersion.



CAUTION

When the analyzer and A0702 is being integrated to an external system, the safety of that system is the responsibility of the assembler of that system.



CAUTION

During installation and operation, do not position the analyzer or A0702 so that it is difficult to operate the disconnecting device (such as an emergency off (EMO) switch or breaker).



WARNING

When using compressed gases, follow all appropriate safety conventions, including use of eye protection, physical restraint of cylinders, etc.



CAUTION

Ensure warm air is exhausted from an enclosure where the A0702 is mounted.

4.2 Tools Required (Not supplied)

- 5/8" open end wrench
- 3/4" open end wrench
- 9/16" open end wrench
- 11/16" open end wrench
- Sample chamber

4.3 Connection Overview



NOTE

This setup requires a gas tight sample chamber, including lids and seal, or a soil flux chamber (e.g., Eosense EosAC). Use only Picarro supplied bellows tubing and fittings. Using other tubing and fittings may degrade performance and change system volume.

Figure 4 shows a typical closed system measurement package connection configuration and flow paths.

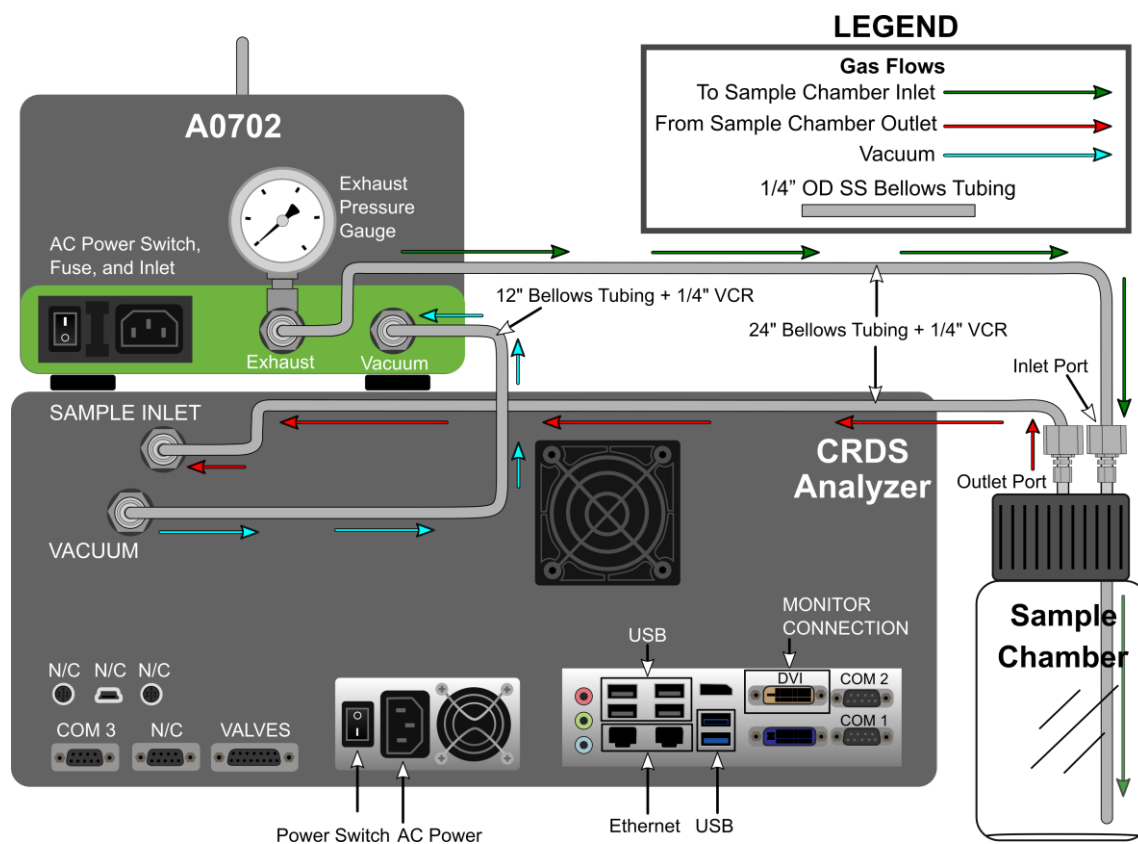

Figure 4: A0702 Connection Schematic



CAUTION

Leave enough free space for ease when making connections. Leave 6” free space at the rear of the pump and 6” free space at the front of the pump.

4.4 Pump to Analyzer Connections

1. Remove the protective caps from the vacuum and exhaust ports on the pump. Save the caps for later use. Reinstall the caps when the pump is stored, moved, or shipped.



CAUTION

Failure to remove the blue end caps from the exhaust fitting on the pump can lead to pump damage.

VCR Adapter Installation

2. As each VCR tubing connection is made, insert a new 1/4” Ni/Ag gasket (Swagelok NI-4-VCR-2) into the VCR nut (Figure 5).
3. **Tightening VCR Fittings:** To ensure a good seal when connecting the following VCR fittings:
 - a. Turn the nut until finger-tight.
 - b. Use a 3/4” wrench (backed with a 5/8” wrench) to tighten the nut an additional 1/8 turn.



CAUTION

Always use a new gasket when reconnecting VCR fittings. A used gasket can be identified by a circular depression on the surface:

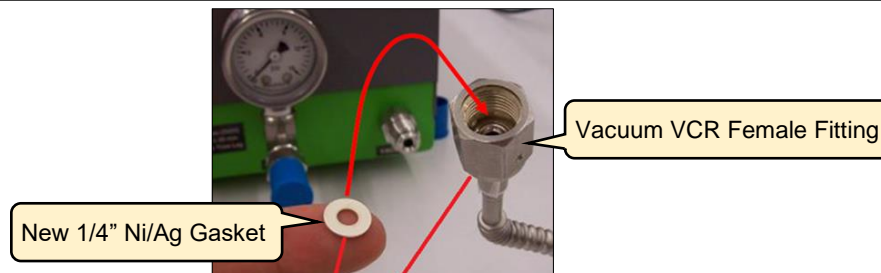

Figure 5: Inserting New Gasket into VCR Female Fitting

4. Attach the 1/4” VCR to 1/4” tube adapter to the analyzer INLET port bulkhead fitting and finger-tighten. Using a 9/16” wrench, tighten 1/4 turn (blue box in Figure 7).

5. The vacuum adapter fittings should come connected, but not tightened together. Tighten the 1/4" nut onto the 1/4" tube-to-1/4" VCR union (Figure 6). *Skipping this step is the most common cause of vacuum leak issues.*

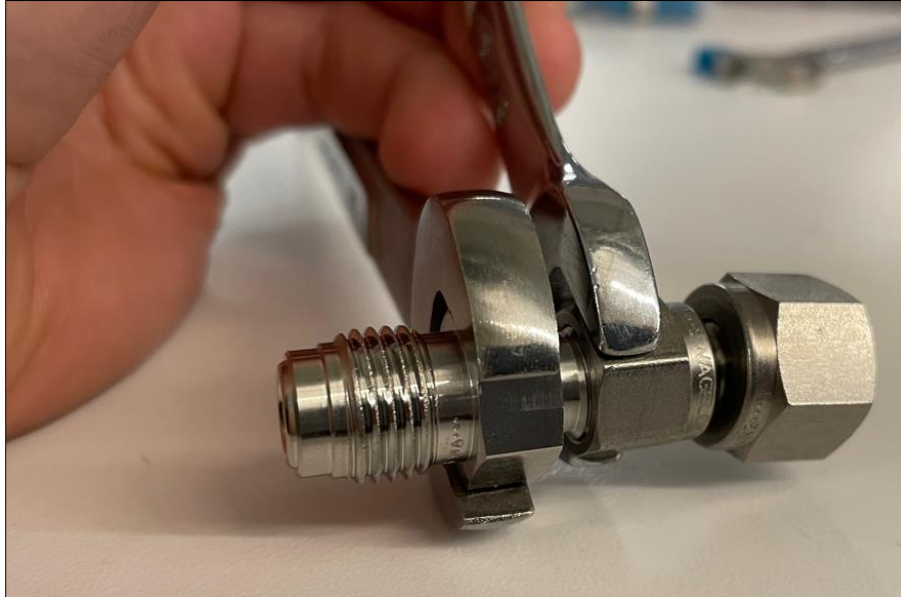

Figure 6: Tightening Vacuum Adapter Fitting

6. Attach the 1/4" VCR to 3/8" tube adapter to the analyzer VACUUM port bulkhead fitting and finger-tighten (red box in left pane of Figure 7). Using the 11/16" wrench, tighten 1/4" to 1/2" turn.

When connecting the vacuum line 3/8" nut to the vacuum port on the Picarro analyzer, ensure that the adaptor union sits straight when tightened in place. See Figure 7 (left and middle panes) for a reference for a correct fitting alignment and see Figure 7 (right pane) for an example of a poor alignment.

*When the fitting is aligned incorrectly, the vacuum line will leak significantly, adding pressure to the sample lines. The user may see a "pressure unlocked" error in the host software GUI that indicates this issue if the leak is large enough, but if the leak is small and the vacuum pump is able to stabilize the cavity pressure, this error may not show up. The procedure in section 5, **Instrument and Pump Leak Test** will reveal this leak, however installing the fitting correctly the first time will avoid potential for damaging the fitting (through cross-threading) and sample vessels (through over-pressurization).*

Some additional guidance on recirculation can be found in manual PN 40-0038, 16-Port Manifold User Manual Including A0311, A0311-S, A0310, which can be obtained by contacting support@picarro.com.

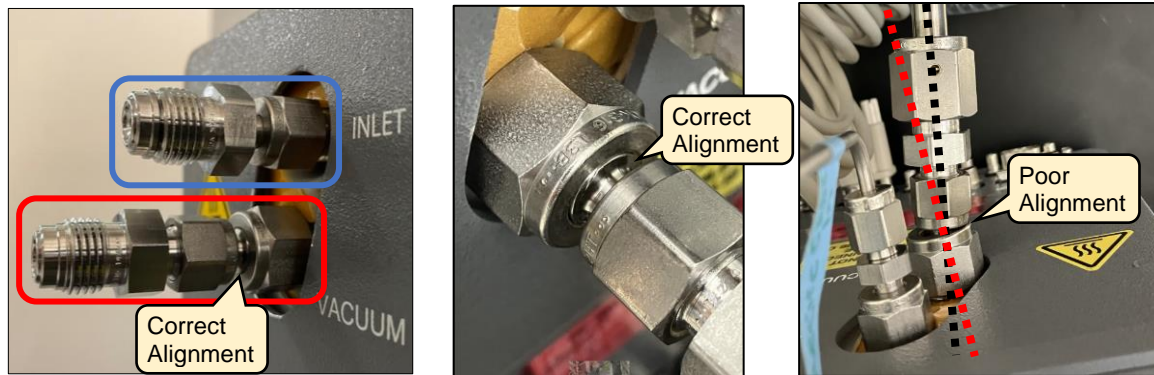

Figure 7: VCR to Analyzer Adapters – Ensure Proper Alignment and Tightness

7. Connect the 12" flexible stainless steel line between the analyzer **Vacuum** port and the A0702 **Vacuum** port. Ensure a new VCR gasket is inserted into each VCR female fitting.



WARNING

Accidentally connecting the vacuum line from the instrument to the exhaust port on the pump can cause back-pressurization of the cavity and serious damage to the analyzer. Ensure you are connecting to the vacuum port on the pump, which should be on the right, and does NOT have a gauge above it. Refer to Figure 4 if needed.

4.5 Initialization



NOTE

See the analyzer manual for detailed instructions on analyzer setup and operation.



CAUTION

Always turn on the pump before turning on the analyzer. This ensures a rapid start up sequence.

Turn on Pump and Analyzer

1. Switch on the A0702 recirculation pump from the rocker switch. The pump should audibly turn on.
2. Switch on the main power to the analyzer by flipping the rocker switch on the back of the analyzer to (|) from (0). If analyzer doesn't turn on immediately, push soft power button on front of analyzer.

3. The instrument will boot, and the operating system and QuickGUI checklist will populate. The instrument host software (green window) will load automatically.
4. Allow instrument to warm up to the cavity temperature set point (typically 45C). This step will take about 25 minutes, but may take up to 60 minutes for systems with higher temperature set points.
5. During warmup, especially about 20 minutes in, when Cavity Pressure drops quickly and controls at the set point, watch the log in the bottom of the window for any “pressure unlocked” alerts. If any such alerts occur, check all fittings on the vacuum line.
6. After the instrument warms up to the cavity temperature set point, it will begin reporting values. Allow the analyzer another 20-30 minutes for values to stabilize before performing any calibrations or measurements.

4.6 Setting up Recirculation

1. With the analyzer running, and with the sample chamber available, attach the two 1/4” VCR to 1/8” Male NPT adapters to the Sample Chamber Inlet and Outlet ports (Figure 7) using Teflon tape or similar sealant on the 1/8” NPT threads to ensure leaktightness.



NOTE

Many operators will use the 1/8” NPT fitting to connect into their sample vessel or chamber. However, not all chambers will accept an 1/8” NPT thread. Consult www.swagelok.com for other VCR adaptor fitting options. If the user needs more guidance, they should support@picarro.com or the chamber manufacturer.



Figure 8: 1/4” VCR to 1/8” NPT Male Adapters (shown with and without temporary endcaps)

2. Connect one of the 24" flexible stainless steel lines between the analyzer **Inlet** port and the sample chamber **Outlet** port (this may not be specified on all chambers, but is generally the upper of the two fittings farther from the sample soil or solution). Ensure a new VCR gasket is inserted into each fitting.
3. Connect the other 24" flexible stainless steel line between the A0702 **Exhaust** port and the sample chamber **Inlet** port. Ensure a new VCR gasket is inserted into each fitting.

At this point, the recirculation system is set up, and the user should see evidence of the gas concentrations either eventually stabilizing if the sample chamber is empty or changing if it contains sample material. Users running Ball Jar incubations may swap out the ball jar, leaving the lid connected to the recirculation system.

4.7 Calculating Fluxes

The A0702 system provides the hardware for recirculation along with third party or user-designed sample chambers.

Users may choose between three options for calculating fluxes for their samples:

1. **Most complete solution:** using third party hardware—like the eosAC chambers and eosMX multiplexers from Eosense.com—and associated software. Users operating such hardware should confirm that the software is properly installed on the Picarro analyzer computer and follow the manufacturer's instructions for operation.
2. **Simplest:** using the **Picarro Soil Flux Processor** software, which can be purchased from the relevant Picarro sales manager or partner.
3. **Most Flexible and inexpensive:** performing the flux calculations by hand.

In all cases, users should be careful to ensure they have entered in the relevant volumes and surface areas of the containers and components used in the system so that concentration changes noted by the Picarro can be transformed into the relevant units (typically $\mu\text{mol}/\text{m}^2/\text{s}$ or $\text{mmol}/\text{m}^2/\text{s}$) correctly.

The total standard volume of the A0702, tubing, and G2508 Picarro instrument is 105 ± 10 SCCS at sea level. The total volume estimate should be adjusted downward proportional to the ambient pressure of the user's location. In Boulder, CO, for example, where ambient pressure is about 630 torr, the total volume is likely to be closer to $(630/760 \text{ torr}) * 105 = 87$ SCCS. Testing of the G2508 volume in Boulder, CO and Santa Clara, CA confirms this relationship.

5. Instrument and Pump Leak Test

5.1 Introduction

Comprehensive leak-testing of an important flow circuit requires careful attention, some strategy, and a few essential tools. Picarro cannot provide a comprehensive guide to leak checking fully assembled recirculation experiments, because the sample chamber an operator uses varies from application to application. However, we do provide one important tool—the outlet pressure gauge on the A0702 pump. The gauge can be used to determine the leak-tightness of a completed sample circuit or of just the instrument and pump.

Two types of leaks may occur in a recirculation setting: an inward leak on the vacuum line, or an outward leak on the circuit between the pump outlet and instrument inlet.

- An outward leak is important, but typically less impactful on the system since the pressure differential is small. This can also theoretically be tested with Swagelok Snoop, or equivalent leak checking solution.
- An inward leak can be significantly more impactful because the difference in pressure between outside and the vacuum line (typically 600+ torr) can lead to rapid change in the pressure and concentrations in the system. This cannot however be observed using Snoop, as the solution would be drawn into the instrument by an inward leak. Instead, look for an increase in pressure on the gauge on the A0702 pump outlet after an equilibration period of a few minutes. Increasing pressure indicates added mass in the system from an inward leak.



CAUTION

Leak checking solution should not be used for inward leak testing due to the risk of pulling the solution into the pump, sample vessel, and potentially, the analyzer.

Picarro cannot give a relevant leak spec for a user's complete system, because the leak rate in PSI/hour on the exhaust gauge will depend on the total system volume, which can vary greatly between incubation jars and large flux chambers. Accordingly, we provide a leak spec for just the instrument and pump of 0.05 SCCM because we know the typical system volume to be roughly 105 SCCs at sea level when the instrument is connected to the pump via the bellows tubing, and when one bellows tubing is plumbed back to the instrument inlet. This leak test may be performed to ensure leak-free closed system integrity following the diagram shown below.

5.2 Leak Test Procedure

Refer to Figure 9 below for the following steps.

1. With the analyzer running and measuring per the User Manual, disconnect the **Sample Outlet** 24" bellows tubing from the analyzer **Sample Inlet** and move it aside.
2. Disconnect the 24" bellows tubing from **Sample Chamber Inlet Port** and connect it to the analyzer **Sample Inlet** port to create a minimum volume loop. *Always use a new VCR gasket whenever disconnecting and reconnecting VCR fittings.*
3. The pressure on the exhaust gauge can increase over the first couple of minutes as the sample loop equilibrates its pressure. Continue to observe for the first 10 minutes to see if the pressure increases rapidly, and if not, note the baseline pressure, and begin the 12 hour leak test. The increase in system pressure should be less than 5 PSI over 12 hours, roughly equal to a 0.05 SCCM inward leak.
4. If the system pressure increases more than 5 PSI over 12 hours, recheck all fittings, especially on the vacuum line, and confirm all are snug and contain VCR gaskets when appropriate.

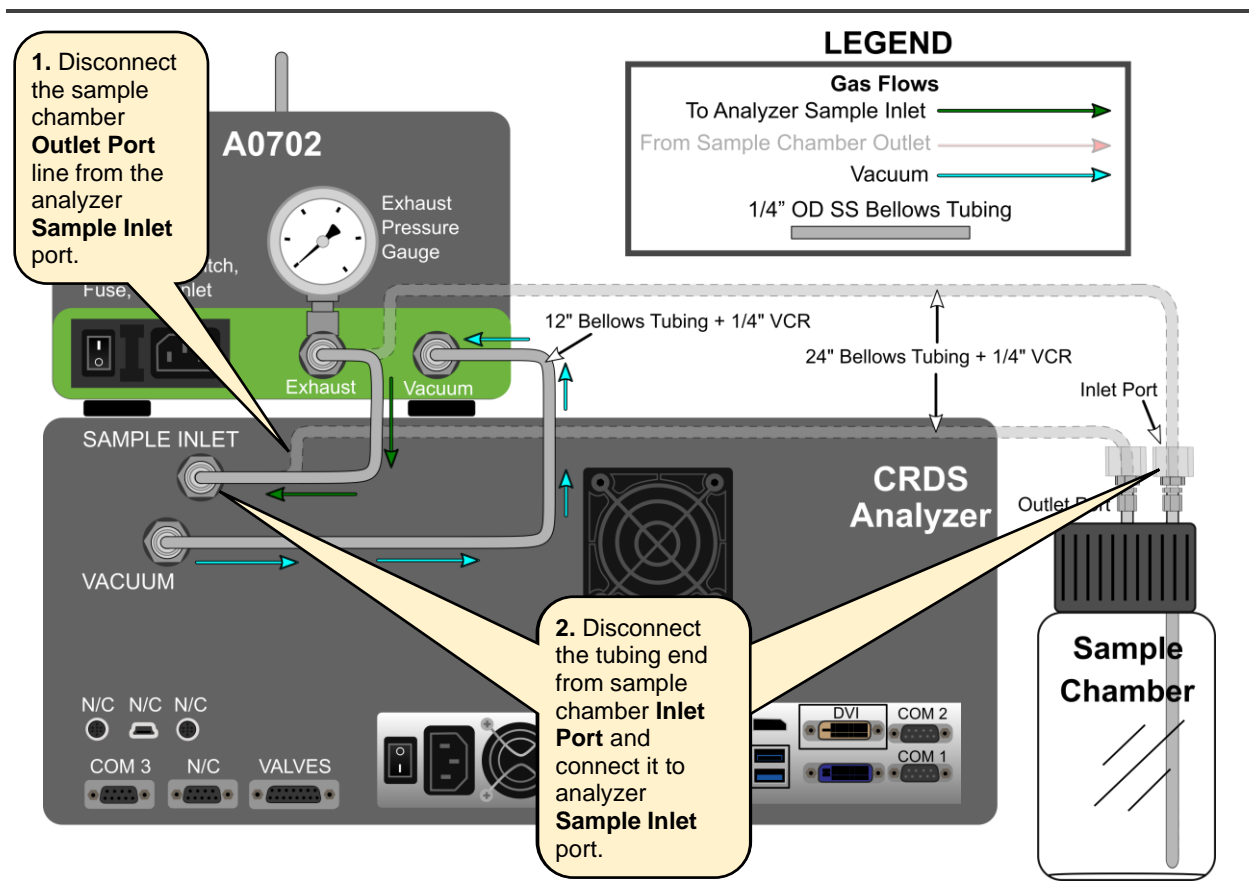

Figure 9: Configuring for A0702 Closed System Leak Test

6. Maintenance

6.1 Fuse Replacement

The A0702 recirculation pump uses a 1.5A / 250 VAC, 5mm x 20mm, slow blow fuse. Follow this procedure to replace the fuse. Figure 10 shows the fused power connector on the rear panel of the pump.

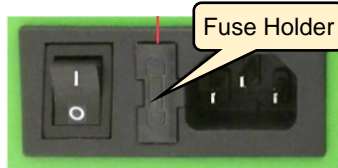

Figure 10: Fused Power Connector



WARNING

Before replacing a fuse, make sure that the pump power switch is in the OFF position and that the pump power cord is disconnected.

1. Insert a screw driver flat head under the tab on the fuse housing as shown in Figure 11.
2. Carefully push the screw driver handle away from you to lever the fuse housing out of the pump back panel.
3. Remove the fuse from the fuse housing.
4. Put a new fuse in the fuse holder.
5. Push the fuse holder into the rear panel. You will hear a click when it is fully inserted.

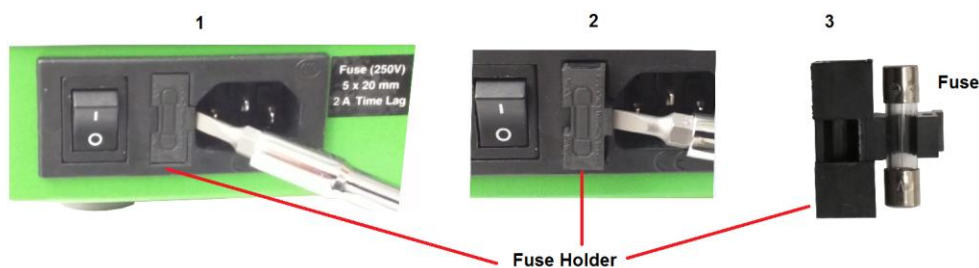

Figure 11: Fuse Replacement

6.2 Cleaning

Clean the outside of the A0702 with a clean dry cloth. Users should never access or clean the inside of the pump.

APPENDIX A – Swagelok VCR Fitting Instructions

See the figure below for detailed instructions on making VCR fitting connections. Features encircled in red are applicable to making VCR connections on an A0702/Analyzer setup.

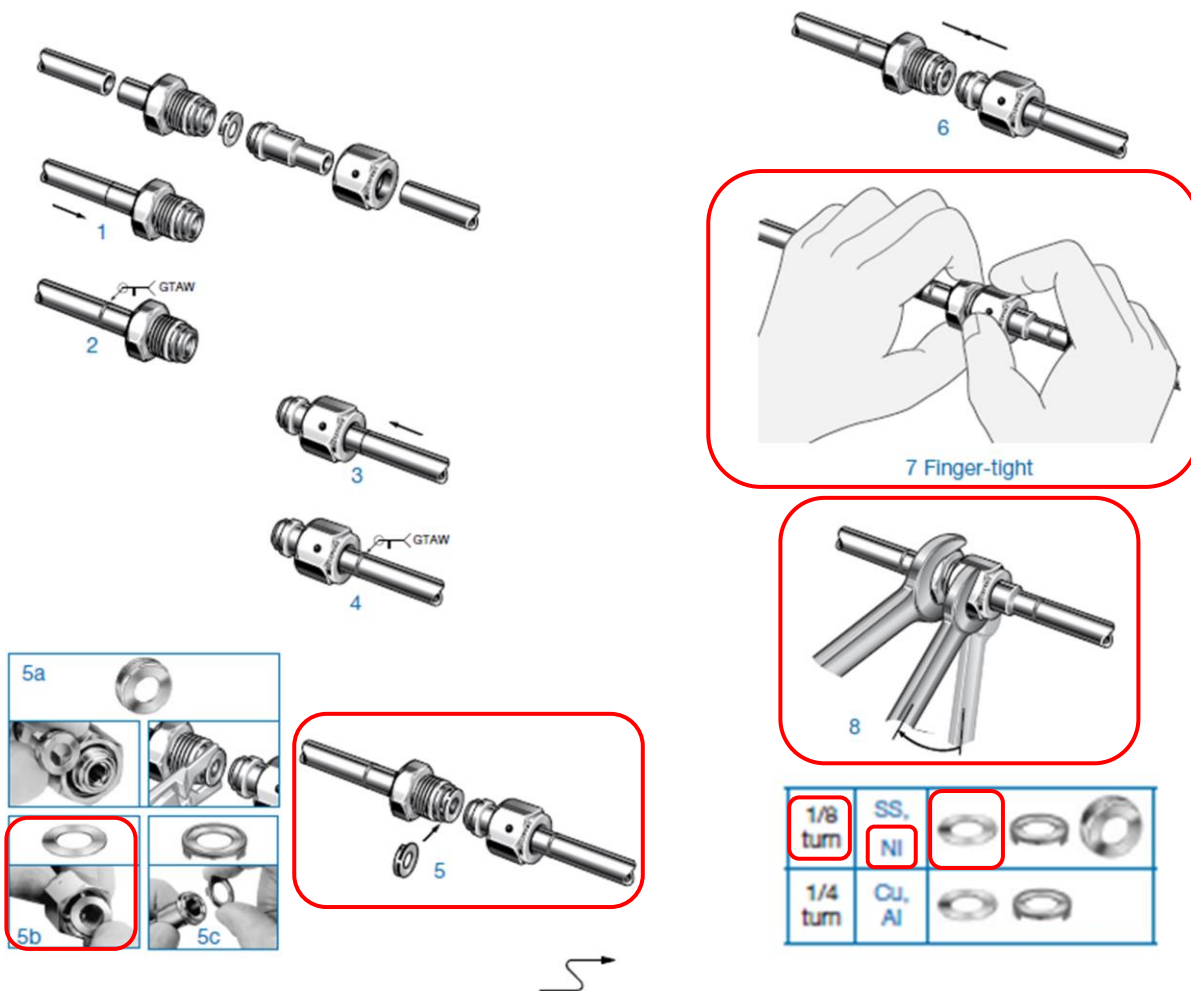

Figure 12: Making a VCR Connection